



Quad Cortex User Manual 1.4
CorOS version 1.4.0

Contents

Welcome to Quad Cortex	3
What is Quad Cortex?	4
Contact info	4
Overview	5
Top View	6
Rear View	6
Bottom View (Inside)	6
Setting up your Quad Cortex	7
Quick Start	8
The Grid	10
Settings Menu	14
Neural DSP account	15
I/O Settings	15
CPU Monitor	18
Presets	19
Working on The Grid	20
Clipping Alert	23
The Directory	23
Saving Presets	25
Setlists	26
Delete, Edit, Cut, Copy	27
Assigning Expression Pedals	28
Expression Bypass	29
Splitters and Mixers	32
Using External IR files	37
Looper X	38
Device Blocks Parameters	43
Modes	47
Switching Modes	48
Preset Mode	48
Scene Mode	49
Copy & Paste Scenes	50
Stomp Mode	51
Gig View	53
Setup Examples	54
Basic Routing	55
FRFR/Direct	56
FRFR Monitor + FRFR to Front-of-House	58
Combo Amplifier	60
Power Amp & Cab + FRFR/Direct	61
Four Cable Method (4cm)	62
Seven Cable Method (7cm)	64
As FX Loop Only	66
As FX Processor (pre only)	67
Using external gear (FX loop)	68
Stereo cab setup	69
Guitar and vocals	70
Two guitars and bass	71
Neural Capture	73
Creating a new Neural Capture	74
Using a Neural Capture	80
Computer Integration	81
USB Audio	82
Hardware & DAW Monitoring	82
MIDI	87
MIDI Settings Menu	88
Preset MIDI Out Settings	88
Incoming MIDI	90
Incoming MIDI Reserved CC List	92
Cortex Cloud	93
Cloud Backups	94
Adding friends	95
Downloading items from other users	96
Uploading Impulse Responses	97
Importing Impulse Responses	99
Uploading a Preset or a Neural Capture to Cortex Cloud	99
Sharing Presets or Neural Captures	100
Making Presets or Neural Captures available to the public	100
Virtual Device List	102
F.A.Q.	112
Specifications	115

01

Welcome to Quad Cortex

When we started Quad Cortex, we had no idea what we were getting into. Naivete can be a good thing.

It took more time, effort, and resources than we could have ever imagined. It forced us to level up at a dizzying pace and to overcome countless challenges.

Quad Cortex was as much engineered as it was willed into existence. And none of it would matter if it wasn't for your belief in us and what we stand for.

For that, we will be forever grateful.

Neural DSP Team.

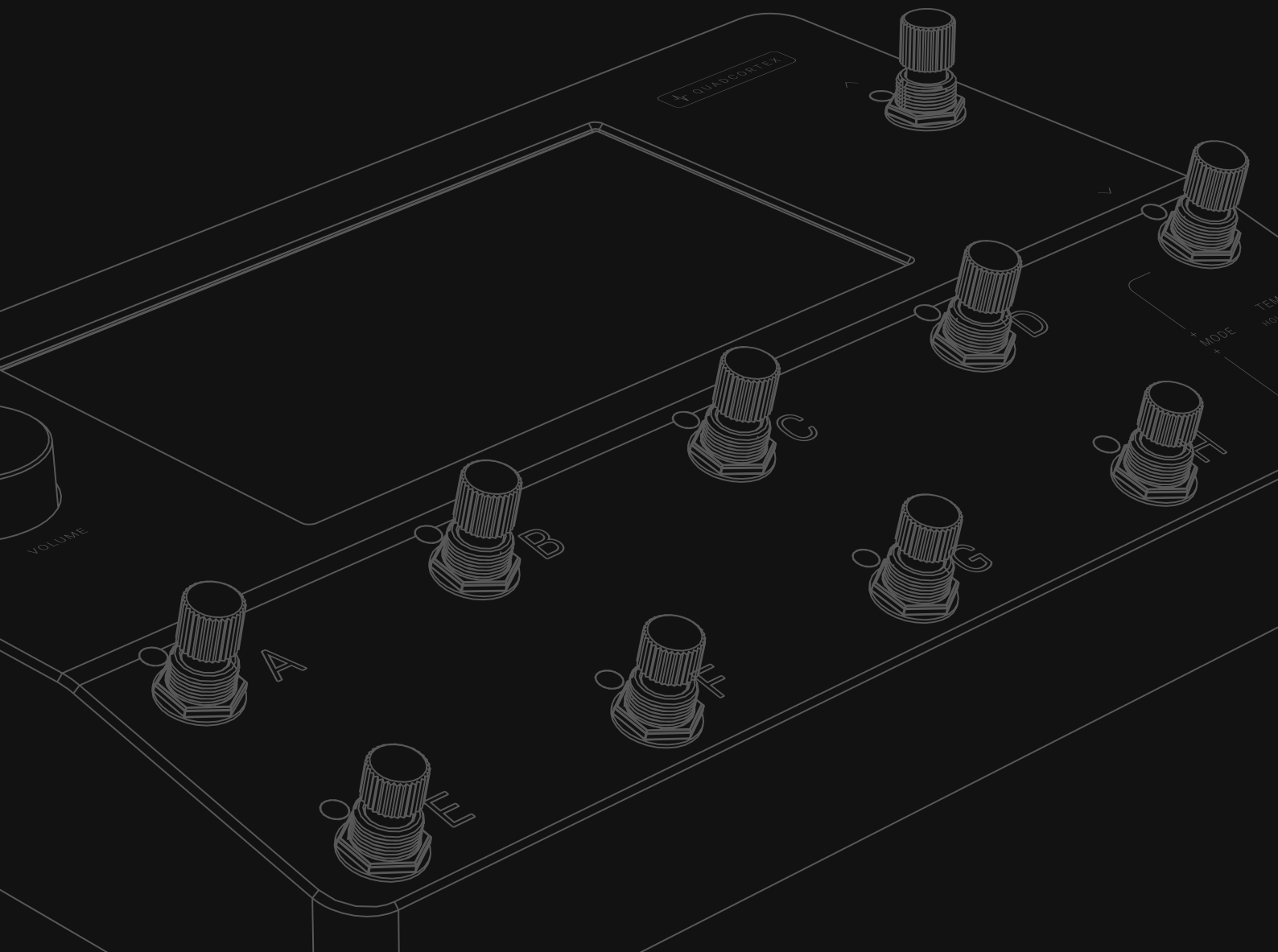

What is Quad Cortex?

— Vulgar Display of Power

Quad Cortex is the most powerful floor modeler on the planet. With a total of 6 cores (4x SHARC®+ and 2x ARM Cortex-A5 running at 500MHz each) of dedicated DSP, this ludicrous amount of processing capacity provides limitless sound design possibilities. Because of that, Quad Cortex can process up to four instruments at the same time with independent effects chains and send them through different outputs separately.

— Unparalleled Intuitiveness & Flexibility

With its massive 7" display, Quad Cortex is unbelievably easy to use. Effortlessly create even the most complex signal paths.

This includes features like dragging-and-dropping blocks to change the order or routing in seconds or visualizing and controlling the settings of inputs and outputs with one swipe.

— Unbelievably Strong & Compact

Quad Cortex comes in a gorgeous anodized aluminum unibody, with laser engraved graphics that never fade. Our display is armored with a chemically strengthened protective glass and a reinforced touch sensor panel.

Using advanced mechanical design and manufacturing techniques, we managed to not only build the most powerful floor modeler/multi-effects processor on the planet, we also managed to pack it all in an extremely compact format.

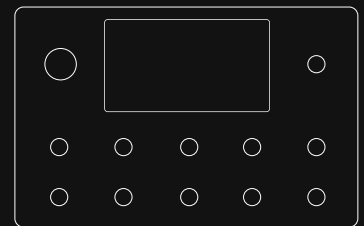

Dimensions:
29 x 19 x 4.9cm
Weight:
1.95kg / 4.2lbs

— Cortex Mobile

Discover Users, Presets, and Neural Captures using Cortex Mobile.



Contact info

For technical issues or any problems experienced with our hardware, please visit cortex-support.neuraldsp.com

— Service Centers

For information regarding Quad Cortex service centers, please visit cortex-support.neuraldsp.com or contact support@neuraldsp.com.

02

Overview

Quad Cortex weighs 1.95kg / 4.2lbs and its dimensions are 29 x 19 x 4.9cm.

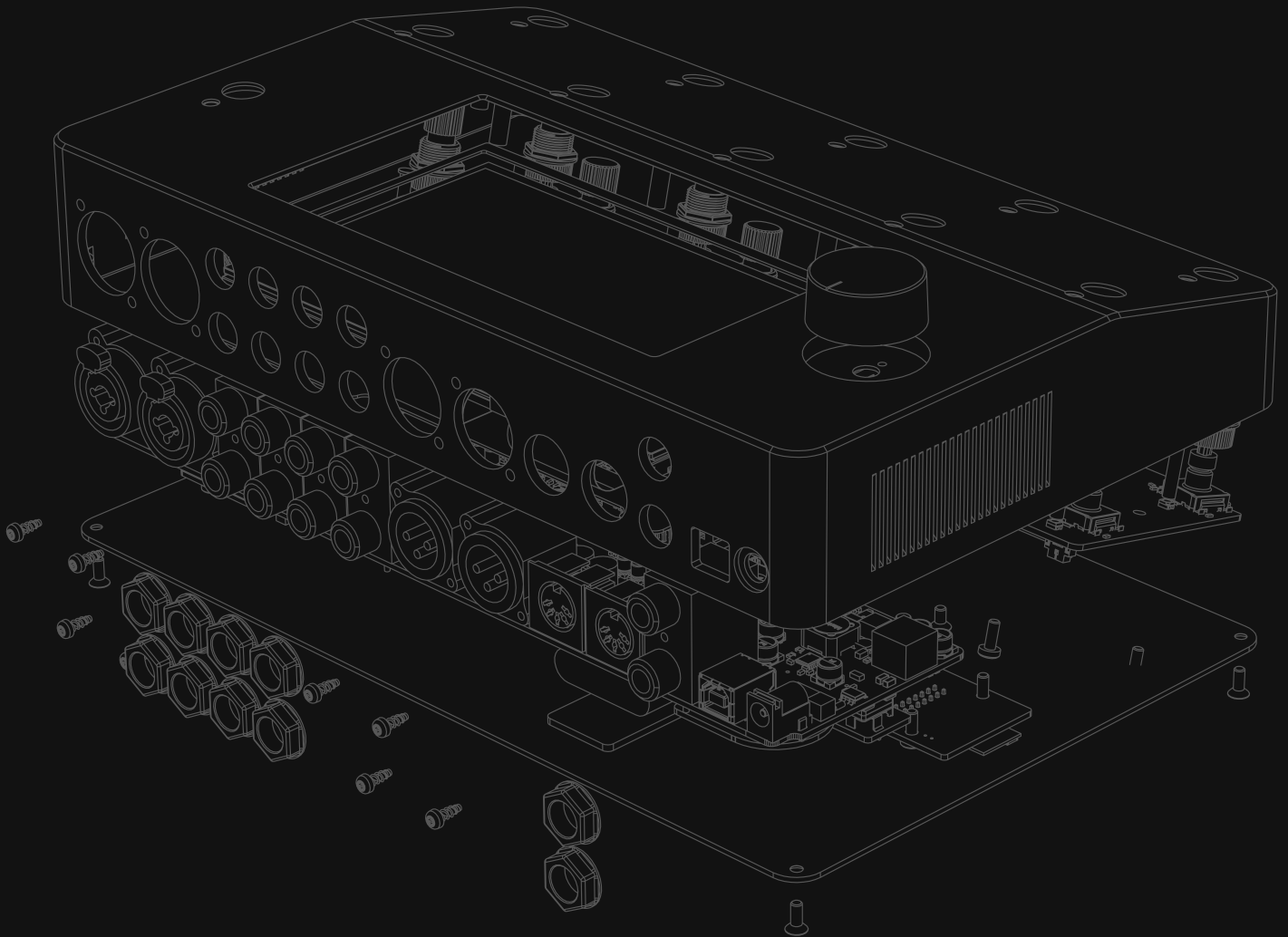

Top View

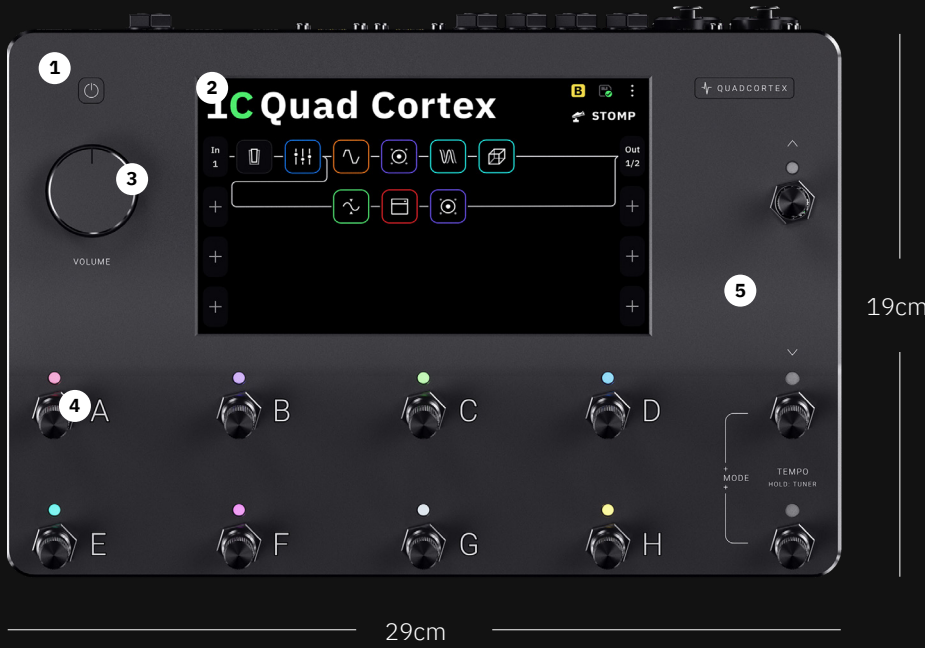

Top View Dimensions:
29 x 19cm / 11.4" x 7.4"

- 1 Power Button
- 2 7" display
- 3 Volume Wheel
- 4 11 stainless steel stomp + rotary actuators
- 5 Chassis made of anodized aluminum

Rear View



Rear View Dimensions:
29 x 4.9cm / 11.4" x 1.9"

- 1 Dual Combo Inputs: TS, TRS, and XLR
- 2 Dual FX-loops
- 3 1/4" TRS Outputs
- 4 Capture Output
- 5 Headphones Output
- 6 XLR Outputs
- 7 MIDI In, Out/Thru
- 8 Dual Expression Inputs
- 9 USB Type-B
- 10 Power Input (12V-3A)

Bottom View (Inside)

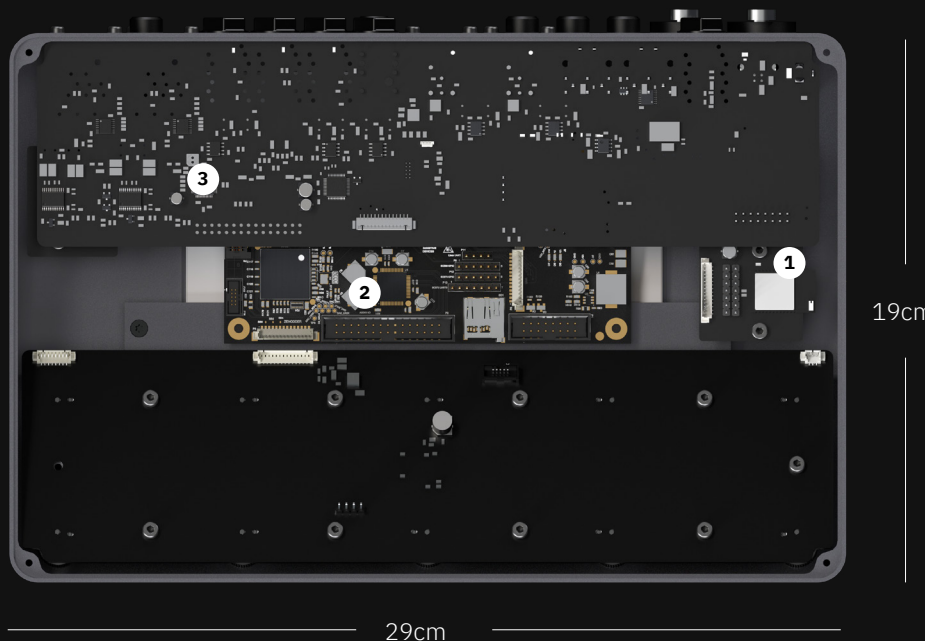

Bottom Dimensions:
29 x 19cm / 11.4" x 7.4"

- 1 IEEE 802.11 b/g/n Wi-Fi module (2.4GHz ISM band)
- 2 4x SHARC+ & 2x ARM Cortex-A5 cores
- 3 USB Audio Class 2.0 Compliant

03

Setting up your Quad Cortex

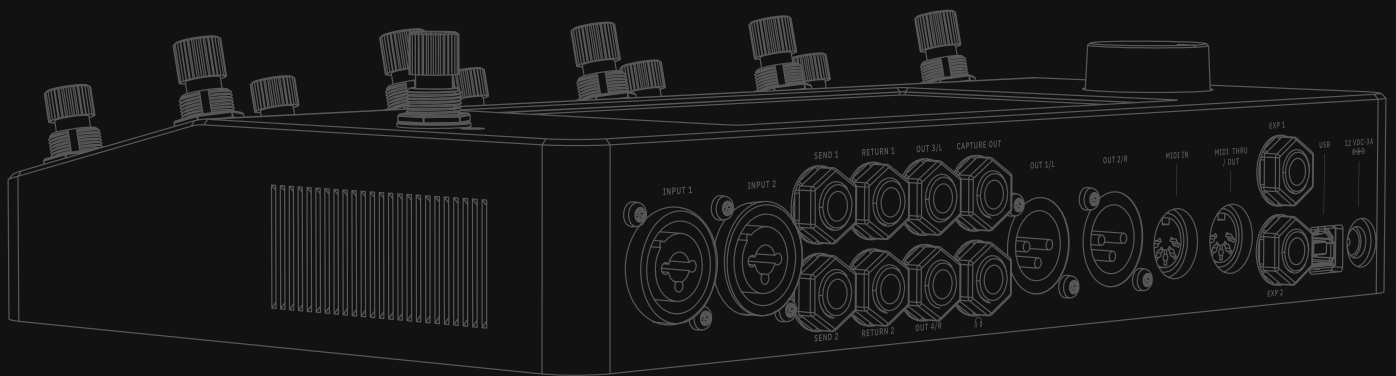

Quick Start

— Turning on your Quad Cortex

To turn the Quad Cortex on, connect the power cable to the input on the back and wait for it to power up.

— Connecting your gear

Before connecting your instrument, make sure the volume wheel is turned down.

Connect your instrument to **Input 1**.

Connect your studio monitors, PA, or FRFR cabinet to either **XLR Outs 1/2** or **TRS Outs 3/4**.

Alternatively, if you want to use headphones, connect them to the Headphones output.

If you're not sure about the correct input/output levels, check the [I/O Settings](#) section.

— Changing Modes

Tap the name of the mode currently active at the top-right of the display or press the furthest-right footswitches on the bottom two rows together.

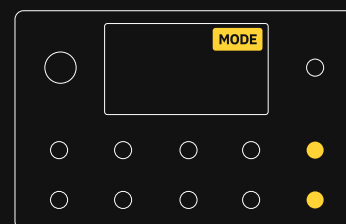

— Browsing Presets

While in Preset Mode, press footswitches A-H to switch Presets.

Press the Up/Down footswitches to navigate through the Preset banks.

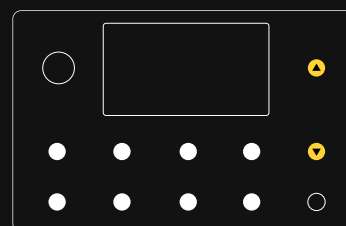

— Tuner

 Press and hold the bottom-right footswitch to activate the **Tuner**.

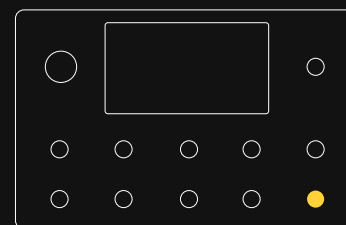

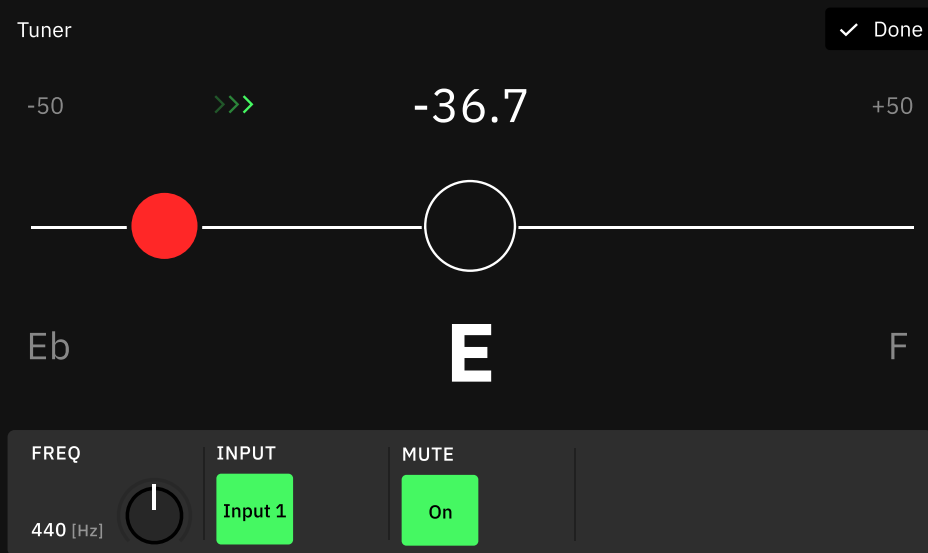

It is also possible to feed both **Inputs 1/2** simultaneously to the Tuner.

This allows for USB playback and the Looper to continue feeding signal to the outputs while the tuner is being used.

Frequency Selector (Hz): Modifies the tuner reference (440Hz by default).

Input Selector: Determines which Input the tuner will listen to (Input 1 by default).

Mute Button: Determines whether the INPUT selected is muted or not when the Tuner is activated.

— Tap Tempo

2 **Double-press** the bottom-right footswitch to engage the Tap Tempo feature. Keep pressing to modify the tempo value.

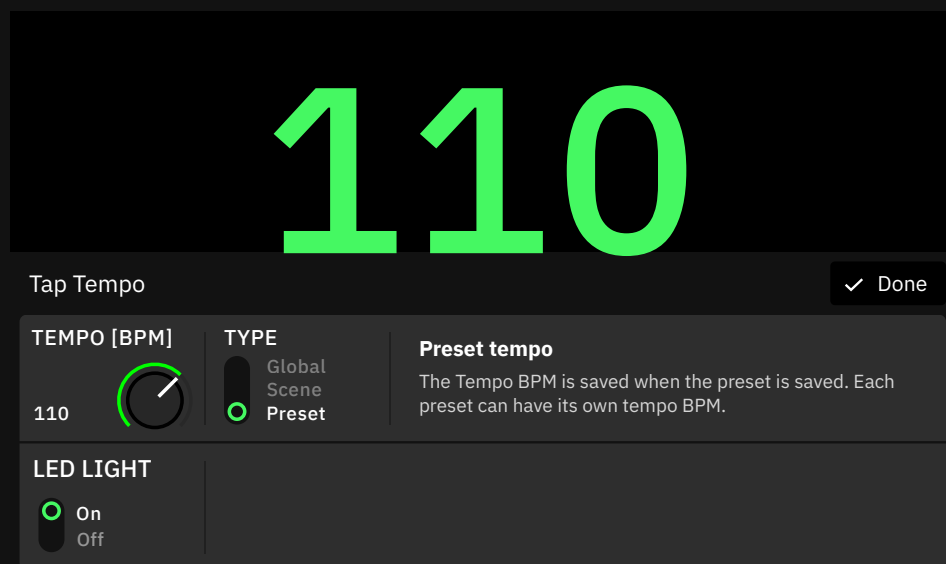
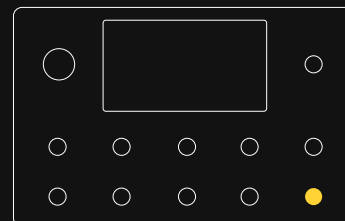

Global Tempo: The tempo is the same for each Preset/Scene until you set a new tempo.

Scene Tempo: The tempo is tracked in each of the 8 Scenes. The tempo set in each Scene is saved when the Preset is saved.

Preset Tempo: The tempo is saved when the Preset is saved. Each Preset can have its own tempo.

LED Light switch: Tap to activate/deactivate the the Tempo LED light.

The Grid

We call the screen where you can add blocks to build a virtual rig “The Grid”.

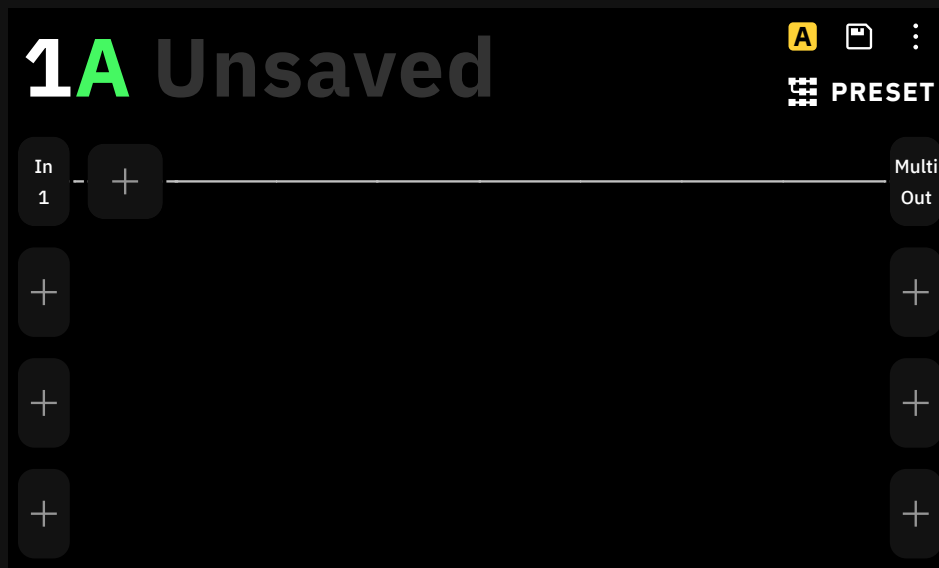

The Grid has four rows of eight virtual device block spaces. Almost all the items on the screen can be controlled by using gestures, rotary actuators, or dedicated commands.

— Gestures and Commands

To turn Quad Cortex off, press the capacitive power button and select **SHUT DOWN**. You can also remove the power cable from the back of Quad Cortex.

Main Menu: Touch the upper-right corner of The Grid to access the Main Menu.

Swipe down from the top of the screen to access the **I/O Settings** screen.

Swipe up from the bottom of the screen to access **Gig View**.

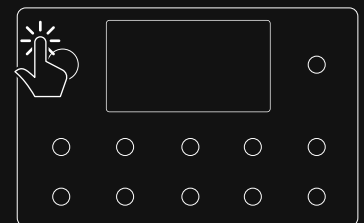

Check the [Power Functions](#) section for more information.

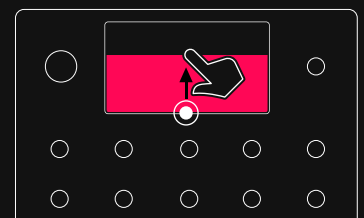
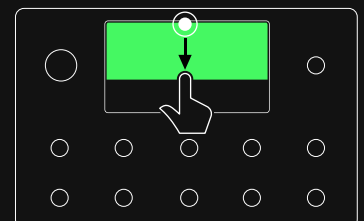

Tap on an empty space in The Grid to create a new **Virtual Device Block**.



Double-tap a block to **bypass/activate** it.

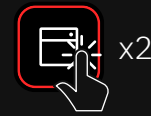

Tap on a block to access its parameters. You can either use the touch controls on the screen or the rotary actuators to modify the parameters.

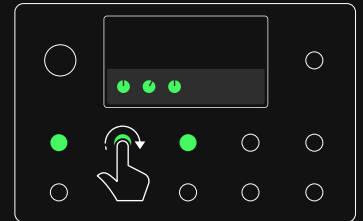

When a block menu is open, turn the **top-right rotary actuator** clockwise or counterclockwise to navigate through the virtual devices or Neural Captures within the same category without opening the Virtual Devices Library.

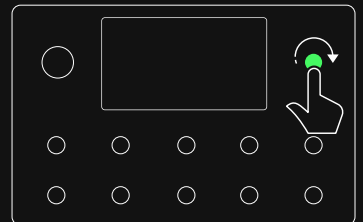

Turning the top-right rotary actuator also changes **the position of the caret in any text field**.

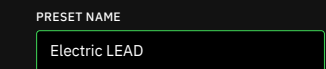

Tap on a parameter value to fine control. Write a value with the numeric keyboard and tap  to change it. This also works in the **I/O Settings** menu.

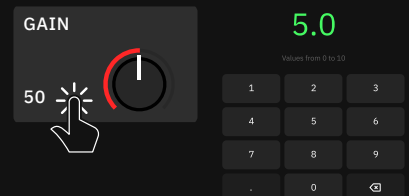

Tap and hold a device block to drag-and-drop it to another place on The Grid. Drag a block to the upper-right corner to remove it.

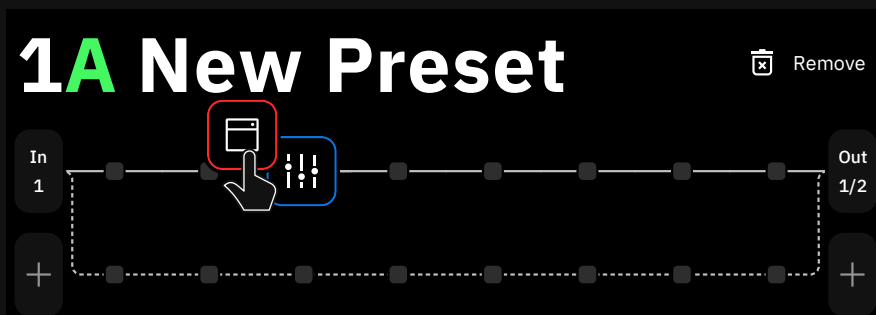

For more details, check the [Working on The Grid](#) section.

Tap on the **input** and **output blocks** to modify them. You can create, edit, and assign them to physical or virtual I/Os.

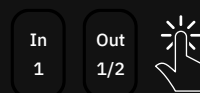

Tap and hold on an **input block** to access the **Input Gate Control** menu.

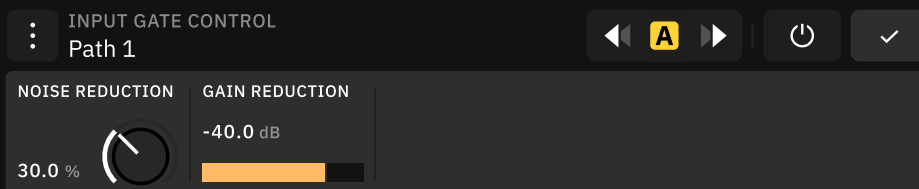

These controls can be assigned to Scenes and Expression Pedals. A color strip displays on the input block when the **GAIN REDUCTION** is activated.



Tap and hold an **output block** to access the **Lane Output Control** menu.

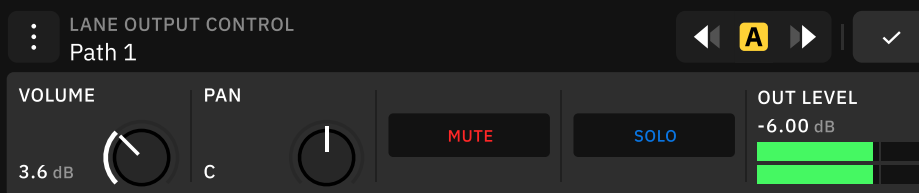

These controls can be assigned to Scenes and Expression Pedals. Color strips display on the Output block when **MUTE** and/or **SOLO** are activated.



Tap and hold on an empty space on The Grid to create a **Splitter/Mixer** path.

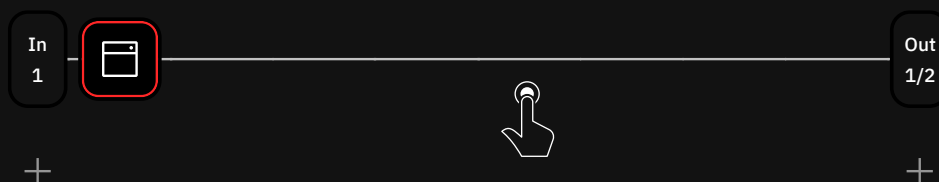

If you move any block vertically in The Grid a Splitter/Mixer path will be created automatically.

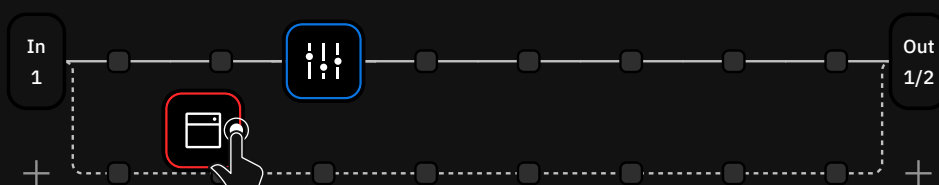

— Power Functions



Touch the **power button**. This will pop up a window with different functions:

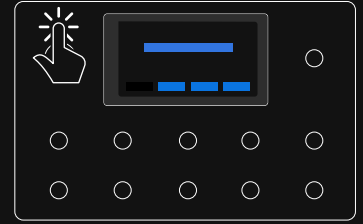

LOCK: Both touchscreen and Master Volume wheel will be locked. While locked, a lock indicator displays at the top-right of the screen. To unlock, **press-and-hold** the power button. If the Master Volume knob is moved while locked, the volume will not change until the knob is first turned to reach the value set when the knob was locked.

CANCEL: Tap to close the Power Functions window.

SHUT DOWN: Quad Cortex will shut down. If you want to turn Quad Cortex on again, press the power button.

REBOOT: Quad Cortex will reboot. Note that any unsaved changes will be lost if you change the power state.

STANDBY: All audio outputs will disable and the screen will turn off. Press the power button to wake Quad Cortex and re-enable audio outputs.

— Recovery Mode

Press and hold the **A** and **H footswitches** the first 6 seconds of the splash screen while booting to initiate the Recovery Mode.

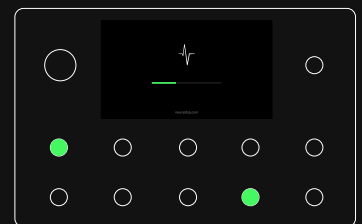

CANCEL: Tap to close the Recovery Options window. Quad Cortex will boot up.

RESET SETTINGS: Tap to restore Quad Cortex to its default settings. User data (Preset, Captures, etc) will not be removed.

FACTORY RESET: Tap to remove all user data. Quad Cortex will be restored to factory settings.

Settings Menu

You can find the settings in the **Main Menu**.

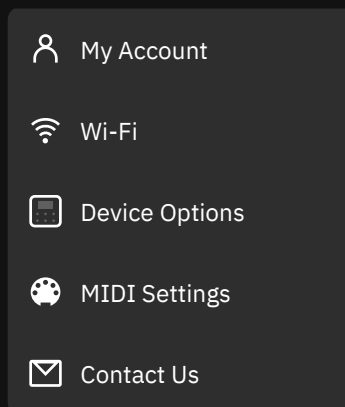
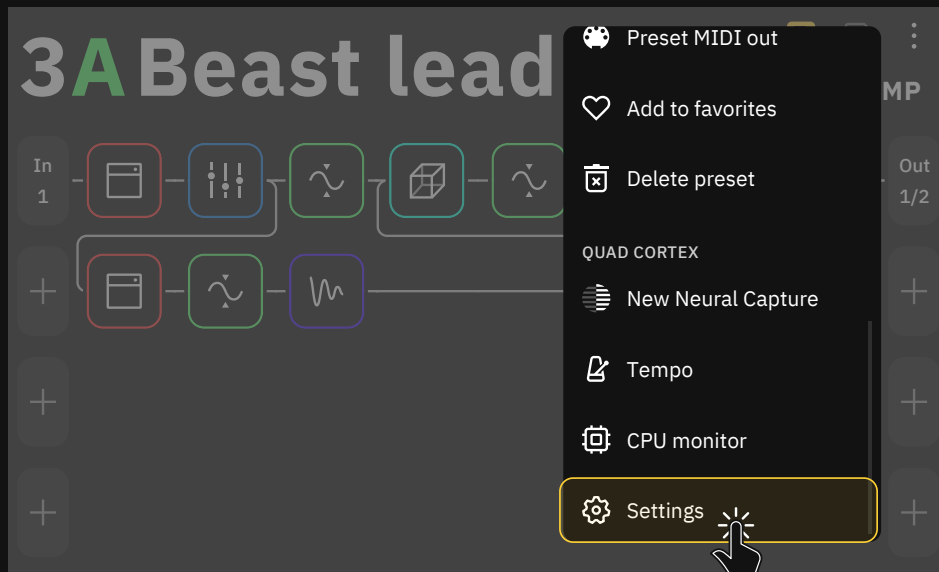

My Account: Here you can link your Quad Cortex with your Neural DSP account. You must be logged into your Neural DSP account to sync your library, and share or download items from other users.

Wi-Fi: Connect to Wi-Fi in order to access Cortex Cloud and share content. Quad Cortex operates on the 2.4GHz band.

Device Options:

- **Device updates:** Here you can update your Quad Cortex to the latest version of CorOS. The installation requires restarting Quad Cortex to complete.
- **Disk Space:** Available storage space.
- **Diagnostics:** DSP diagnostics and usage statistics.
- **Power button sensitivity:** Configures the amount of pressure needed to trigger the power button (off, low, medium, and high).
- **Brightness:** Use the top-right footswitches to set the desired brightness level for the screen and LED lights. Touchscreen controls are also allowed.
- **About:** Version information.
- **Restart:** Use this feature to restart Quad Cortex. Any unsaved changes will be lost.
- **Restart Wi-Fi settings:** Erases all stored Wi-Fi networks.
- **Factory Reset:** Use this feature to erase everything on Quad Cortex and reset to factory settings.

MIDI settings: Enable or disable MIDI channels, MIDI Thru, or sending MIDI over USB.

Contact Us: Send diagnostic information if you encounter an issue.

Neural DSP account

You can log in to your Neural DSP account on your Quad Cortex.

— Linking Quad Cortex with your account

Tap the **Main Menu** on **The Grid**. Go to **Settings, My Account**, and tap the **LOGIN** button. Enter your credentials to log in.



Don't have an account?

[Register here.](#)



— Creating a new account

Go to neuraldsp.com/register to create a new account.

We also include a QR code to access neuraldsp.com/register faster. Open the **Main Menu**, tap **Settings**, and use your phone's camera to scan it.

I/O Settings

Swipe down from the top of The Grid to access the **I/O Settings** screen. Here you can visualize and control the settings of all inputs and outputs.

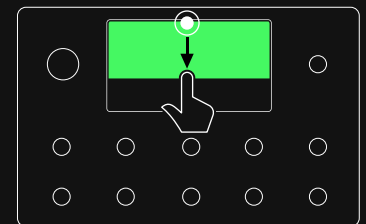

Tap an **I/O port** to change its parameters.



Unused inputs are grey; used inputs are white. Plug something in and see a grey input instantly change to white. Use gestures or the rotary actuators to modify parameters.

Outputs 1/2 and 3/4 can be **paired**. Tapping an output displays the faders for both, but the faders are unpaired. **Long-press** an output to change the pair state. This setting is automatically saved.

— Inputs

IN1/IN2: Combo inputs that allow you to connect your instruments using XLR or TS cables. TRS cables can also be used for gear with balanced outputs.

- **IN LEVEL** KNOB [dB]: Sets the input gain.
- **IMPEDANCE** KNOB [Ω]: Sets the impedance of the Hi-Z input from between 10K to 10M. This option is only available when “TYPE” is set to “Instrument”.
- **TYPE** SWITCH: Toggle between “Mic” (XLR) and “Instrument” (TS/TRS) inputs. If you are using a guitar or bass select “Instrument”.
- **PHANTOM 48V** SWITCH: Enables Phantom Power. This option is only available when “TYPE” is set to “Mic”.
- **GROUND LIFT** SWITCH: Enable to help reduce or eliminate noise caused by ground loops in audio cables or other sources.
- **IN LEVEL:** Input signal meter.

RET1/RET2: Line inputs that allow you to connect your pedals or instruments through TRS cables.

- **RET LEVEL** KNOB [dB]: Sets the input gain.
- **GROUND LIFT** SWITCH: Enable to help reduce or eliminate noise caused by ground loops in audio cables or other sources.
- **RET LEVEL:** Input signal meter.

EXP1/EXP2: Line inputs that allow you to connect your expression pedals through TRS cables.

- **POSITION:** Indicates the minimum and maximum values of your connected device. Move the expression pedal up and down to the minimum and maximum positions to measure it. Tap **SAVE** to keep your settings or tap **RECALIBRATE** to try again.

— Outputs

The **Volume Wheel** controls the output level, and it affects all the outputs. The **I/O Settings** output controls allow you to control the levels of each output independently.

OUT1/OUT2: XLR outputs that allow you to connect Quad Cortex to stereo monitors, FRFR cabinets, PA systems, and more.

- **OUT LEVEL** KNOB: Sets the output level.
- **GROUND LIFT** SWITCH: Enable to help reduce or eliminate noise caused by ground loops in audio cables or other sources.
- **OUT LEVEL** [dB]: Output signal meter.

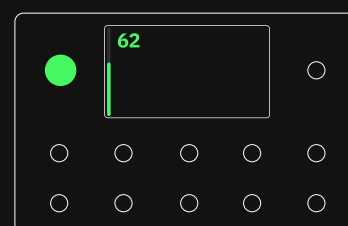

- **LIMITER** [dB]: Gain reduction meter. Allows you to bring up the level without allowing the peaks to clip the output.
- **MUTE SWITCH** [dB]: Tap to activate/deactivate the Output(s).

OUT3/OUT4: TRS outputs that allow you to connect Quad Cortex to stereo monitors, FRFR cabinets, PA systems, and more.

- **OUT LEVEL KNOB** [dB]: Sets the output level.
- **OUT LEVEL** [dB]: Output signal meter.
- **LIMITER** [dB]: Gain reduction meter. Allows you to bring up the level without allowing the peaks to clip the output.
- **MUTE SWITCH** [dB]: Tap to activate/deactivate the Output(s).

SEND1/SEND2: TRS outputs that allow you to connect Quad Cortex to stereo monitors, FRFR cabinets, PA systems, pedals, and more. “TRS to TS” cables are also supported to attenuate hum.

- **SEND LEVEL KNOB:** Sets the output level.
- **OUT LEVEL** [dB]: Output signal meter.
- **LIMITER** [dB]: Gain reduction meter. Allows you to bring up the level without allowing the peaks to clip the output.

HEADPHONES OUT: TRS output that allows you to connect Quad Cortex to stereo headphones. All outputs that are being used on The Grid will display here allowing you to customize your headphone mix.

- **HP LEVEL KNOB:** Sets the output level.
- **OUT KNOBS:** Sets the mix level of the selected output separately.
- **OUT METERS** [dB]: Output signal meters.

CAPTURE OUT: Dedicated output for external devices (Neural Capture only).

— Others

USB: Dedicated port for computer integration.

- **USB LEVEL KNOB:** Sets the level of the audio transmission.
- **HP SELECT KNOB:** The headphones feed when using Quad Cortex as a USB audio interface. It can be set to “None”, “USB 1/2”, “USB 3/4”, or “Both”.
- **DRY-WET SWITCH:** Swap between Clean DI's or processed signal fed into USB Outputs 1-2 or 3-4 (Inputs 1-2 and 3-4 on your DAW).

MIDI IN: MIDI input.

MIDI OUT: MIDI output.

- **MIDI THRU SWITCH:** Enables or disables the MIDI Thru function.

CPU Monitor

The CPU Monitor shows you the overall CPU usage of the current Preset at the top-right corner of the screen. Tap the Main Menu on The Grid and select CPU Monitor to open it.

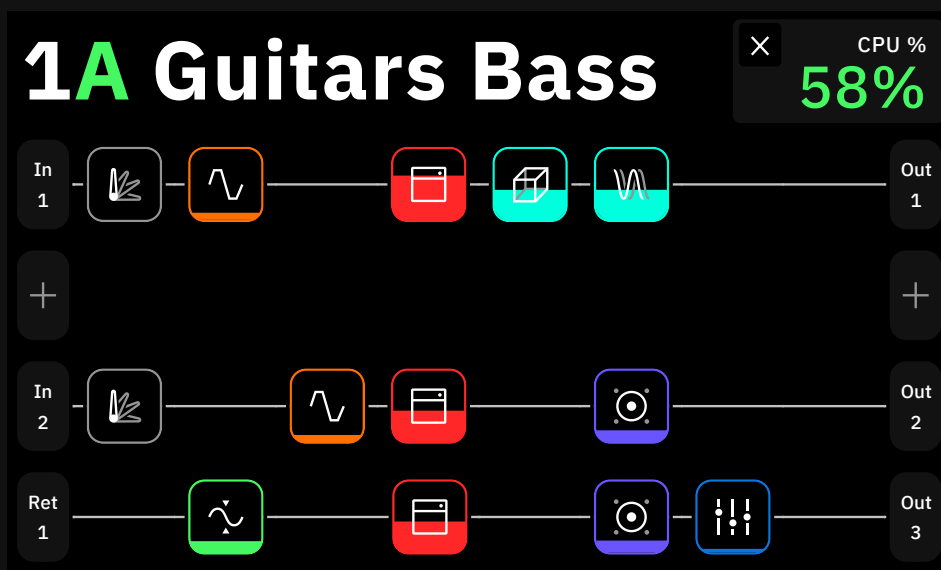

Tap on the **cross button** to close the CPU Monitor.



Each block fills up to represent its influence on the CPU usage.

IMPORTANT: Bypassing/disabling the blocks doesn't decrease the CPU consumption.

— Optimizing performance

Quad Cortex is a DSP (Digital Signal Processing) unit. Different virtual device blocks require more DSP power than others.

To get the most out of Quad Cortex, it is important to understand the following:

- The number of device blocks in a Preset has a great impact on CPU usage.
- Rows 1-2 and Rows 3-4 on The Grid utilise different processor cores. If all of your device blocks are placed in Rows 1 and 2, you're only using half of Quad Cortex's power. For resource-hungry Presets, try splitting your blocks across all four rows.
- The maximum load is up to 90%. Beyond that, the audio and operating system performance may be compromised.
- Time effects like reverbs or delays have the highest CPU usage. EQ, Compressor, Wah, and FX Loop blocks have the lowest CPU usage.
- Some devices may use more DSP than others in the same category. This is especially true with amp devices.
- Use **Scene Mode** to change parameters in devices instead of copying devices and changing their parameters.

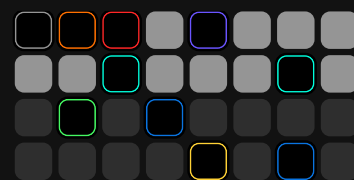
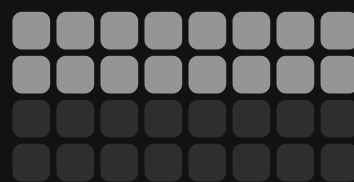

Check the [Scene Mode](#) section for more details.

04

Presets

Presets allow you to create and save custom rigs/signal chains for later use by using device blocks. Quad Cortex Presets are organized in to Setlists, which can contain 32 banks of 8 Presets (256 in total). You can create up to 10 Setlists.

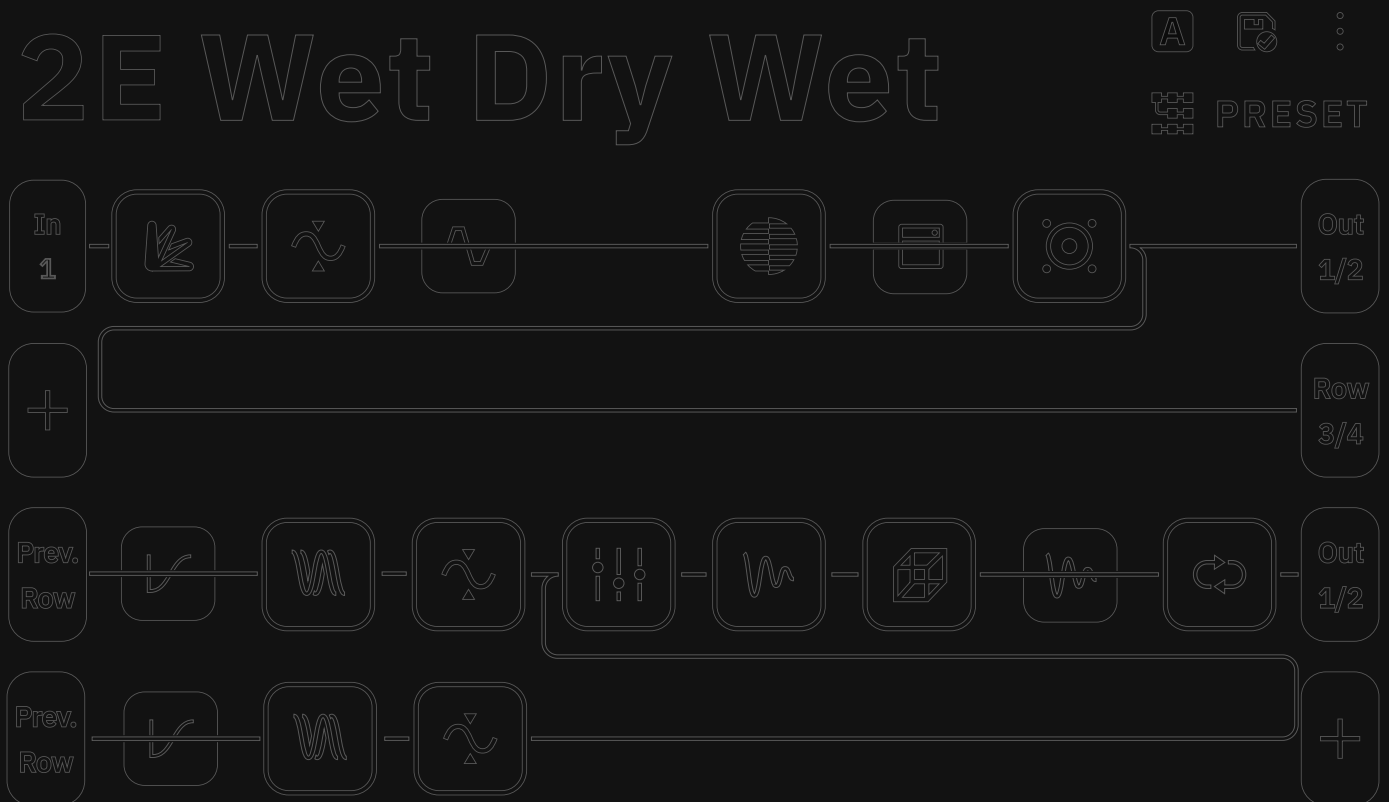

Working on The Grid

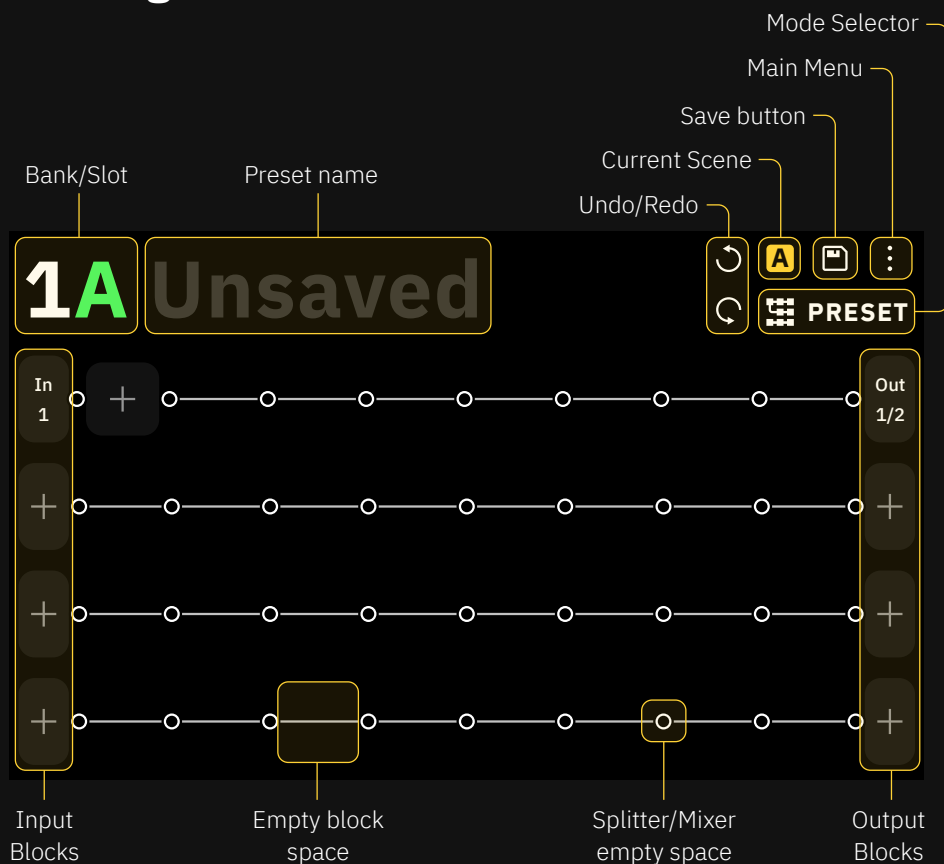

The Grid has four rows of eight device block spaces. Almost all the items on the screen can be controlled by using gestures, rotary actuators, or dedicated commands.

You can start building your own rigs by tapping  on The Grid to add your first block; this will open the Device Category list.



Device Category

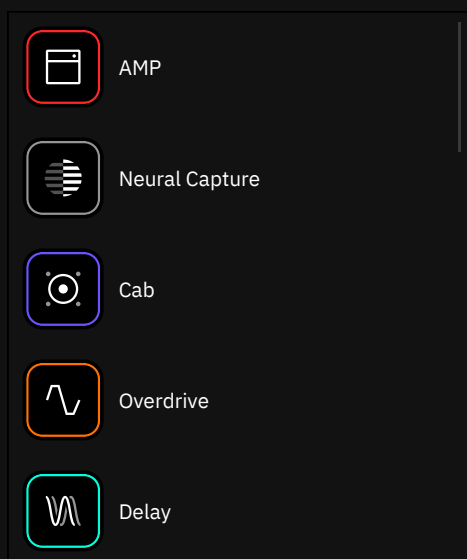

Device Models

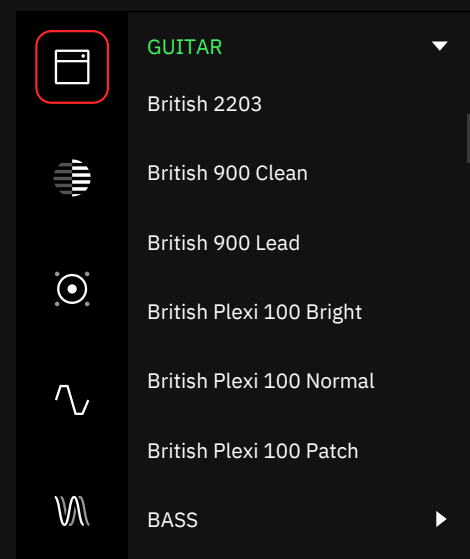

Scroll down by swiping with your finger and tap a device category to display its devices.

Build a virtual rig from left to right. While it's important to remember how you might approach building a signal chain with analog components, dragging-and-dropping a block after you've added it to The Grid is effortless.

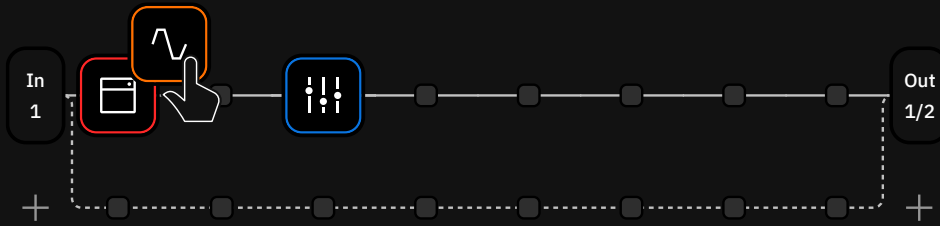



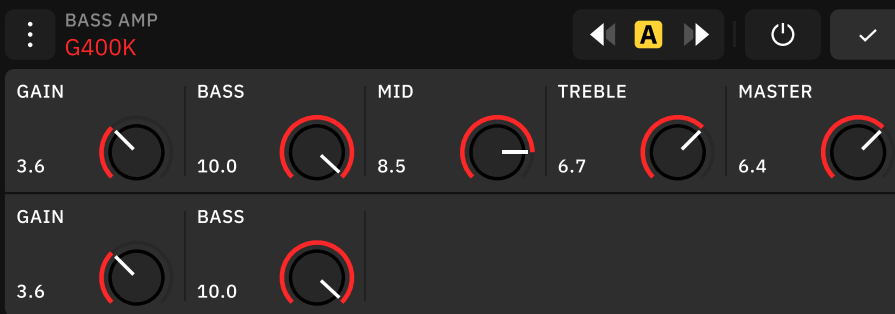



If you add an amp and cab first but need to add an overdrive pedal in front after, repositioning everything is as simple as dragging-and-dropping the blocks into the order you require. Once you have added a block to The Grid, tap it to open its menu.

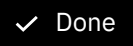

From here, several controls are available to you. Footswitches will light up and correspond to any rotary controls on the block you've added. Parameters such as gain can be controlled either by rotating the footswitch or interacting with the screen.

When a block menu is open, you can tap the contextual menu

 button to reveal further options.

-  **Change Device:** Opens the Virtual Devices Library. Once you tap a device, it changes immediately so you can audition it without leaving the Virtual Devices Library. Tap  to close the menu.
-  **Copy Device:** Copies the selected device and its current settings to the Clipboard. Blocks can be pasted by tapping The Grid to add a new device, then tapping the new “*Paste Device from Clipboard*” button. The Clipboard also allows you to copy and paste blocks between Presets.
-  **Paste Device:** Replaces the selected device with the device stored at the Clipboard.
-  **Reset to Default:** Returns the device controls to their default values.
-  **Set parameters as default:** Sets current control values as default.
-  **Assign Expression Pedal:** Allows you to choose which parameters can be controlled by an expression pedal. Select the expression pedal you want to use before reaching the “Assign Expression Pedal” menu.
-  **Remove block from The Grid:** Removes the device block from The Grid entirely.

 Change device

 Copy device

 Paste device

 reset to defaults

 Set parameters as defaults

 Assign Expression Pedal

 remove block from the grid

For more details, check the [Assigning Expression Pedals](#) section.

When a block menu is open, turn the **top-right rotary actuator** clockwise or counterclockwise to navigate through the virtual devices or Neural Captures within the same category without opening the Virtual Devices Library.

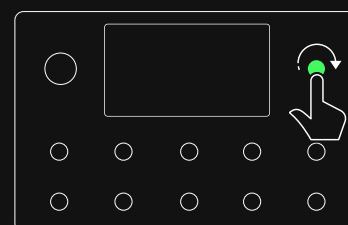

Clipping Alert

In order to keep your signal flow safe, input and output blocks will turn **red** if their selected I/O are clipping the signal.

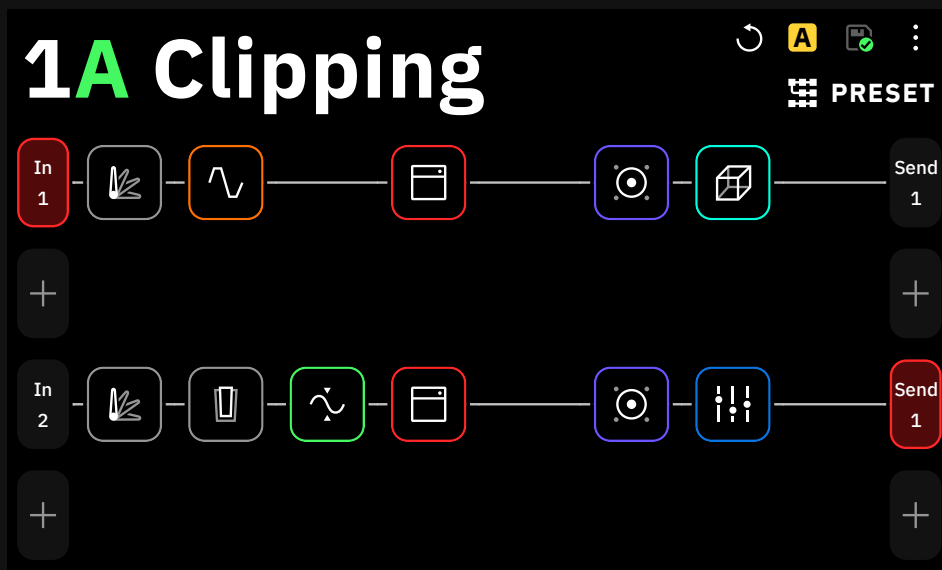

In this particular case, both input **IN 1** and output **SEND 1** are clipping. Decreasing the **IN 1 LEVEL [dB]** value on the **I/O Settings** screen will solve the problem on Row 1. On Row 2, one or more device blocks could be clipping. Checking and changing the device block parameters will solve the problem.

The Directory

Tap the Preset name on **The Grid** to open the **Directory**.

The screenshot shows the '3D Beast Lead' preset interface at the top, with a hand icon pointing at the reverb block. Below it is the Directory screen. The Directory screen has a search bar, a '+ New Setlist' button, and a 'Done' button. On the left is a sidebar with 'Recent', 'Favourites', and 'DEVICE DIRECTORIES' (Factory Library, My Presets, New Setlist, Factory Captures 1). In the center is a 'BANK' grid of 24 slots (4x6), with slot 6 highlighted in green. On the right is a list of preset names: 6A Whatup, 6B Preset 2, 6C Best Machine Riff, 6D Echo Laser, 6E Doesn't Fuzz, 6F Animals as Presidents, 6G Trashpanda, and 6H Heavy Slow Low.

Here you can find all the files you have stored on your Quad Cortex and in Cortex Cloud. Presets, Neural Captures, and Impulse Responses are available here.

Each type of file can be stored in different directories.

Setlists

A Setlist can contain 32 banks of 8 Presets. This feature allows you to categorize your Presets by band, project, album, etc.





— Device Directories

Files stored on the Quad Cortex.

 **Factory Library:** Presets made by Neural DSP.

 **My Presets:** Default user Presets Setlist. Presets downloaded from Cortex Cloud can be stored here as well (256 slots per Setlist).

 **Factory Captures 1 and 2:** Neural Captures provided by Neural DSP.

 **My Captures:** Local Neural Capture storage (1024 slots).

 **Impulse Responses:** Local IR storage (1024 slots).

— Cloud Directories

Files stored on Cortex Cloud.

 **Presets:** Presets stored on Cortex Cloud.

 **Neural Captures:** Neural Captures stored on Cortex Cloud.

 **Impulse Responses:** IR files stored on Cortex Cloud.

— Starred and Shared with Me

Starred files and shared content.

 **Presets:** Starred Presets.

 **Neural Captures:** Starred Neural Captures.

 **Shared with me:** Shared content. Links expire after 90 days.

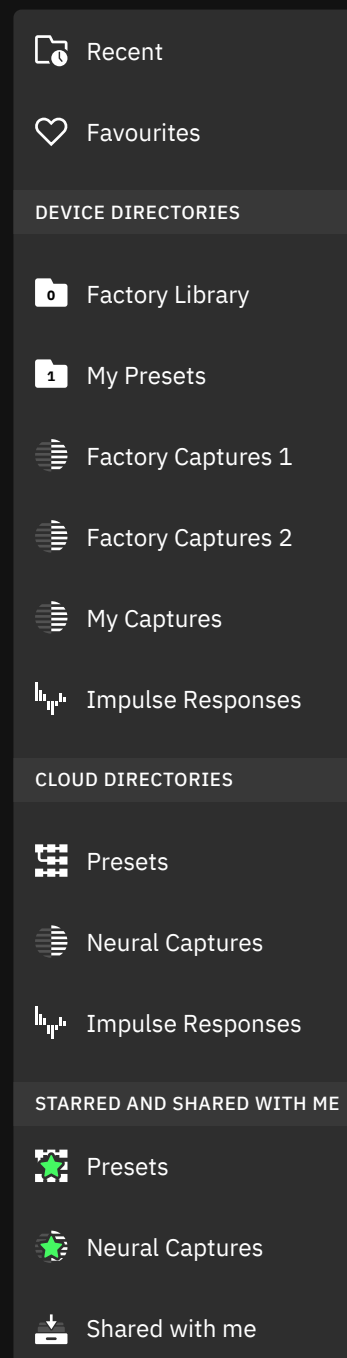

Saving Presets



If a Preset has unsaved changes, the Preset name will be written in *Italic**.

Tap  at the top-right corner to save your changes and overwrite the existing Preset immediately.



You can also go to the menu at the top-right and tap “**Save as...**” to save a rig as a new Preset.



“**Save as...**” is helpful if you have modified a Preset and want to save your changes as a new Preset, as tapping the save icon will overwrite the active Preset with your modifications.

Factory Presets can also be modified and stored as new Presets in any of your Setlists by using the “Save as...” feature.

Setlist My Presets / 1A Change ✕ Cancel

PRESET NAME Electric LEAD TAGS Plini, Lead

q w e r t y u i o p
 a s d f g h j k l
 ⏪ z x c v b n m ⏩
 123 , Space . Save

In the save menu, you can name your Preset as well as assign it tags. Multiple tags have to be separated with a comma and a single space between them.

If you want to know how to share a Preset, please check the [Cortex Cloud](#) section.

Tap My Presets / 1A Change to define the Setlist where you would like to save the preset.

Setlists

Setlists are Quad Cortex’s way of making Presets incredibly easy to use and navigate.

A Setlist can contain 32 banks of 8 Presets, and you can create up to 10 Setlists. This feature allows you to categorize your Presets by band, project, album, or anything else!

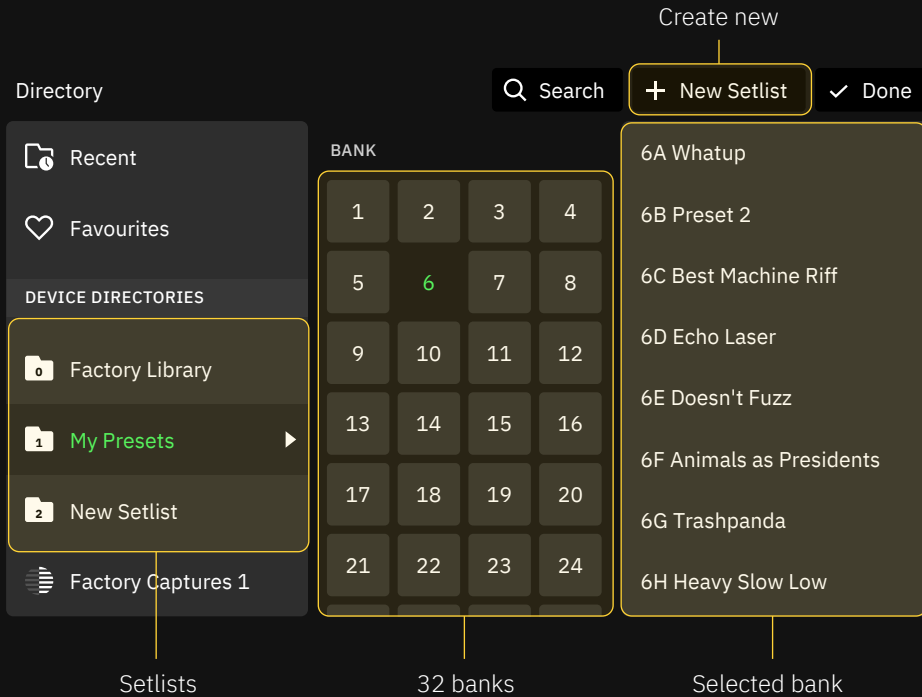

To create a new Setlist, tap the active Preset name at the top of The Grid to open the Directory. Then tap the **“New Setlist”** button at the top-right corner. Give your Setlist a name, then tap **“Create”** at the bottom-right corner.

By default, Presets will save in the active Setlist. When you save a Preset, you have the option to specify the Setlist where you would like to save the Preset.

To change the active Setlist, open the Directory, navigate to the Setlist you’d like to activate, then load a Preset in it by tapping one of the banks, then one of the Presets on the right.

To delete a Setlist, you can drag-and-drop it from the Device Directories list to the upper-right corner of the screen. You will receive a warning dialog asking for confirmation to complete the action.



IMPORTANT: Deleting a Setlist will also remove all Presets inside.

Delete, Edit, Cut, Copy

Open the Directory and tap a bank to reveal its Presets.

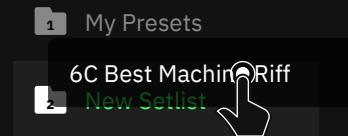
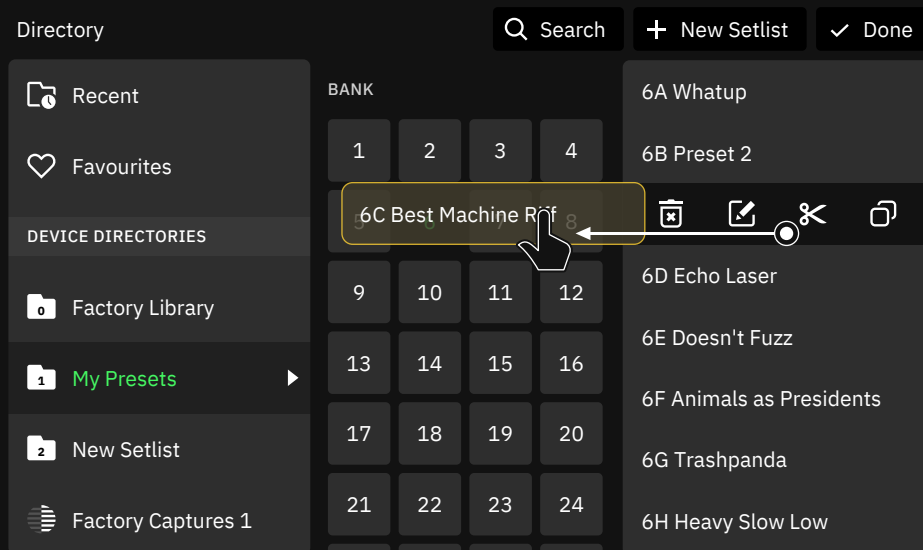



You can also copy Presets by dragging-and-dropping them to another bank or Preset slot.

Swipe to the left on the Preset you want to interact with. This action will reveal four icons:

 **Delete:** Tap it to delete the Preset.

 **Edit:** Modify the Preset's name and tags.

 **Cut:** This action will cut the Preset and send it to the clipboard. Tap another bank block or Preset slot to move the Preset to the selected location.

 **Copy:** This action will copy the Preset and send it to the clipboard. Tap another bank block or Preset slot to paste a new instance of the Preset in the selected location. The new Preset's name will be modified with a number appended to the end.

Assigning Expression Pedals

You can assign an expression pedal to any device (including Splitters, Mixers, and Lane Output Control parameters), and it can control multiple parameters simultaneously.

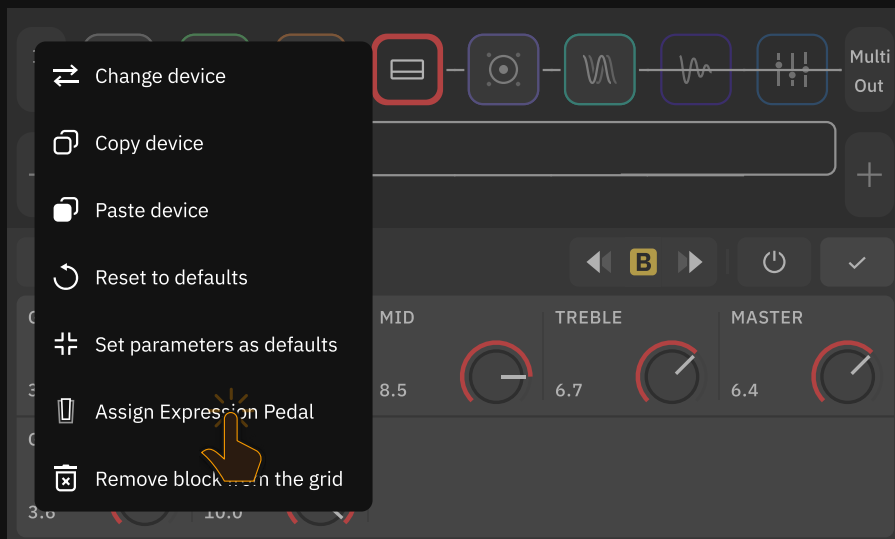

To assign an expression pedal, tap a block on The Grid, tap the contextual menu, then tap “**Assign Expression Pedal**”. Select the expression pedal you want to use to control the block’s parameters.

Assign Expression Pedal

✓ Done

Please choose which parameters you wish to control.
You can assign more than one at once.

DRIVE	MIN RANGE	MAX RANGE			
0.71	0%	100%			
GAIN	DRIVE	BASS	MIDDLE	MID FREQ	
ASSIGN	ASSIGNED	ASSIGN	ASSIGNED	ASSIGN	
TREBLE	MASTER	BYPASS			
ASSIGN	ASSIGN	ASSIGN			



Use the “**Assign**” button to assign a parameter to the expression pedal, and use the button to modify the minimum and maximum values accessible in the pedal’s sweep. Press the “**Done**” button at the top-right corner when you’re finished.

It’s important to remember to calibrate your expression pedal via the **I/O Settings**.

Expression Bypass

The Expression Bypass feature allows to engage and bypass device blocks automatically.

First, assign an expression pedal to a device block. Tap a block on The Grid, tap the contextual menu, then tap “**Assign Expression Pedal**”. Select the expression pedal you want to use to control the block’s parameters.

 Use the “**ASSIGN**” button to assign the expression pedal to the **BYPASS** parameter. Use the  button to access its options.

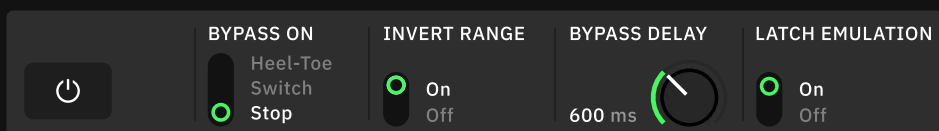

— BYPASS ON

- **Heel-Toe:** Heel down the expression pedal to bypass the device block. When INVERT RANGE is set to “On” the block can be bypassed at Toe position.
- **Switch:** Pressing the toe-switch of the expression pedal will bypass the device block.
- **Stop:** Keeping the expression pedal still will bypass the device block

— INVERT RANGE

(Heel-Toe and Switch modes)

- **ON/OFF SWITCH:** Reverses the value where the bypass is engaged.

— BYPASS DELAY

(Heel-Toe and Switch modes)

- **TIME KNOB:** Sets the time it takes for the device block to be bypassed (Up to 5000ms).

— LATCH EMULATION

(Switch mode)

- **ON/OFF SWITCH:** Modifies momentary toe-switches behavior to emulate latching response.

Can a single expression pedal with dual TRS outputs be connected to Quad Cortex?

Many expression pedals include dual TRS outputs, each one associated with different parameters such as heel-toe sweep control or a physical toe-switch.

Connecting each TRS output of an expression pedal to both EXP inputs of Quad Cortex allows you to control a parameter position and bypass the device block with the toe-switch at the same time.

1. Connect both TRS cables to EXP1 and EXP2 inputs of Quad Cortex. Swipe down the screen to access the I/O Settings menu. Calibrate both **POSITION** knobs then save the changes.

2. Tap a block on The Grid, tap the contextual menu, then select “**Assign Expression Pedal**”. Choose the **Expression input 1**. If the TRS connected to it corresponds to the heel-toe sweep, assign it to the parameter you want to control.

Tap  when you are ready.

3. Tap the same block on The Grid, tap the contextual menu, then select “**Assign Expression Pedal**” again. Choose the **Expression input 2** this time. If the TRS connected to it corresponds to the physical toe-switch, assign it to the **BYPASS** parameter.

4. Select the **Switch** mode then press the toe-switch. You can revert the range if the value is inverted. Turn on the **LATCH EMULATION** if the expression pedal includes a momentary toe-switch.

Are the assignments remembered while switching presets and scenes?

The EXP inputs assigned to a device block can be remembered by using the “Set parameters as defaults” option after assigning an expression pedal to a parameter.

The parameter position and the toe-switch polarity are not remembered while saving Presets. The current parameter position and toe-switch state are maintained while loading presets.

When a parameter is assigned to an expression pedal, the Scene data is also ignored for that parameter.

What expression pedals are supported?

Quad Cortex is compatible with many different expression pedals. Devices with the following features should function correctly:

- Single TRS expression output (Wah or Volume outputs are not supported).
- Dual TRS outputs (Sweep control and toe-switch dedicated outputs).
- Latching toe-switch.
- Momentary toe-switches will only work when latching emulation is set to “On”.
- Linear or logarithmic curve.
- Minimum value knob.
- Polarity/Reverse function.

Splitters and Mixers

Splitters and Mixers allow you to split your signal chain to route your signal to multiple outputs or add more virtual device blocks to The Grid.

Tap and hold an empty space on The Grid in order to create a Splitter/Mixer path that splits the Row in two.

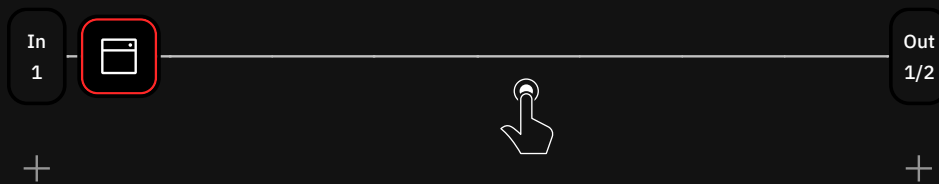

If you move any block vertically on The Grid between Rows 1 & 2 or 3 & 4, a **Splitter/Mixer** path will be created automatically.

Splitter	
TYPE	STEREO
Crossover A/B	Split
<input checked="" type="radio"/> Balance	<input checked="" type="radio"/> Normal
BALANCE	8.5
LEVEL TO A	6.7
LEVEL TO B	6.4
FREQUENCY	BASS
3.6	<input checked="" type="radio"/> Regular
	<input type="radio"/> Invert

The Multi-Out block routes your signal through XLR Outs 1/2 as well as TRS Outs 3/4, and USB. It's the default setting for all Factory Presets and newly created Presets.

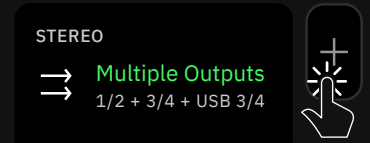

Tap any output block in The Grid then select "Multiple Outputs" to enable this feature.

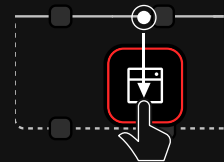

The Splitter S sets the location where the signal splits.

The Mixer M sets the location where the signal joins a Row again.

Detailed parameters are available for Splitters and Mixers that allow for switching between types, shortcut buttons for quick splits, and an on/off toggle.

Putting them in place

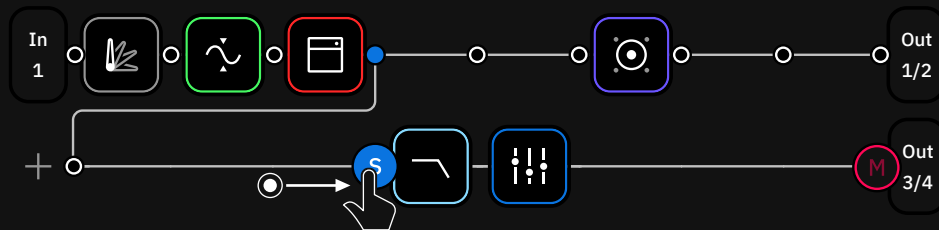

Drag-and-drop the **S** and **M** icons to split and mix the signal at your desired points. This action will modify the chain shape.

Parameters

Once you tap on either the **S** Splitter or **M** Mixer icons, you gain access to their parameters.

Quick splits



We have designed two shortcuts for the most common path types. Tap one to add it to The Grid.

Splitter types:

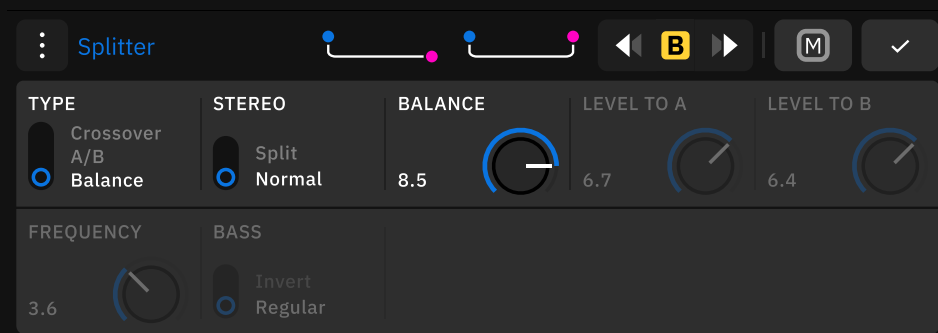

Balance: Uses a single knob to distribute the signal to the Rows.

- **BALANCE KNOB:** Sets the signal mix between the Row and the Splitter/Mixer path (0.50 by default).

A/B: Uses independent knobs for each row.

- **LEVEL TO A KNOB:** Sets the amount of signal to the row.
- **LEVEL TO B KNOB:** Sets the amount of signal to the Splitter/Mixer path.

Crossover: Splits the signal into independent frequency bands that are sent separately.

- **FREQUENCY KNOB:** Sets the frequency cut value.
- **MODE SWITCH:** Swaps the band assignment.

Splitter Stereo Switch

This switch determines the Splitter behavior while using stereo sources like **Input 1/2**, **Return 1/2**, **USB input 5/6** and **USB input 7/8**.

- **Split Mode:** Sends the right input (Input 2, Return 2, USB input 6 or 8) to the Splitter/Mixer path.
- **Normal Mode:** Sends both left and right inputs to the Splitter/Mixer path.

Mixer settings:

Depending on the Mixer location and Splitter settings, the Mixer can receive input signal from **two sources** at the same time. Check the following example:

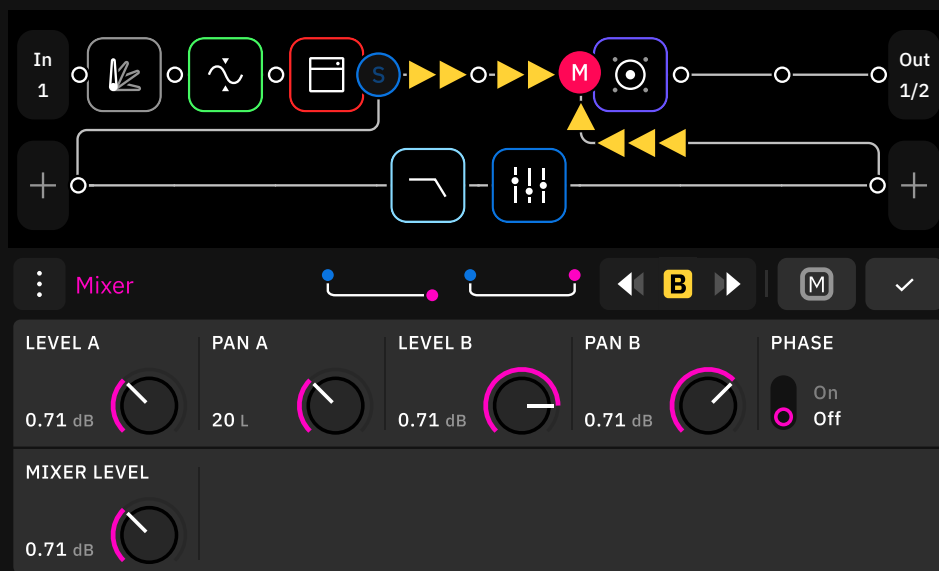

In this particular case, both row 1 and the Splitter/Mixer path are feeding the Mixer input. Use the following parameters in order to control the signal levels.

- **LEVEL A KNOB:** Sets the row signal level.
- **PAN A KNOB:** Controls the panning of the row.
- **LEVEL B KNOB:** Sets the Splitter/Mixer level.
- **PAN B KNOB:** Controls the panning of the Splitter/Mixer path.
- **PHASE SWITCH:** Inverts the phase of the signal workflow.
- **MIXER LEVEL KNOB:** Controls the overall level of the Mixer.

— Dual-row workflow

Up to two Splitter/Mixer paths can be created in a single Preset. Take a look at the following example:

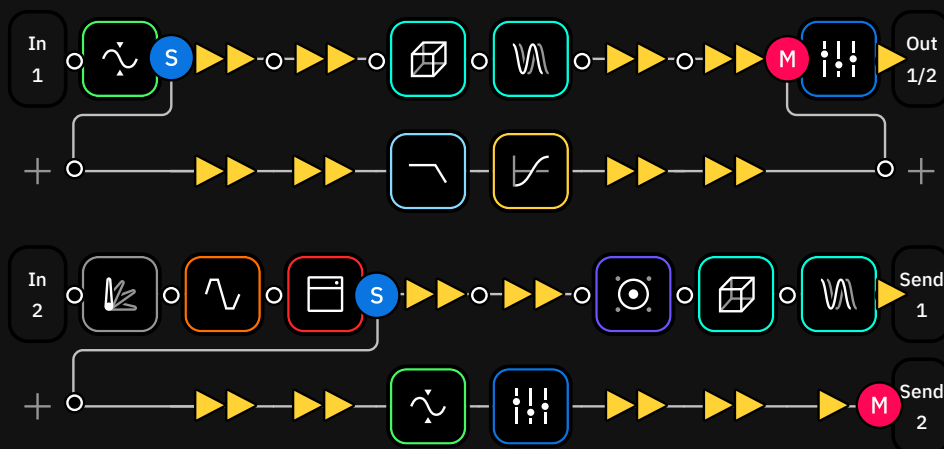

This could be a Preset for Vocals (Rows 1-2) and a Guitar+Cab Bypass (Rows 3-4).

Vocal chain:

- The vocal signal splits immediately after the compressor to Row 2. This Splitter is using the Balance type, so the signal is distributed to both rows equally.
- The Mixer joins Row 1 before the EQ. This Mixer receives input signal from both rows in order to use the Outputs 1/2.

Guitar chain:

- The Splitter is placed immediately after the amplifier. This Splitter is using the A/B type, so the signal is sent to both rows with custom levels.
- Row 3 sends the signal straight to the Send 1 output, including the cab and time effects.
- Row 4 receives signal from Input 1 after the amplifier. A noise gate and EQ are added, and the signal is sent to the Send 2 output to be processed without the cab or time effects.

4-Row workflow

Splitter/Mixer paths can be created between Rows 1 and 2 and between Rows 3 and 4 exclusively. However, if you need to use all available rows for a huge chain, check the following example:

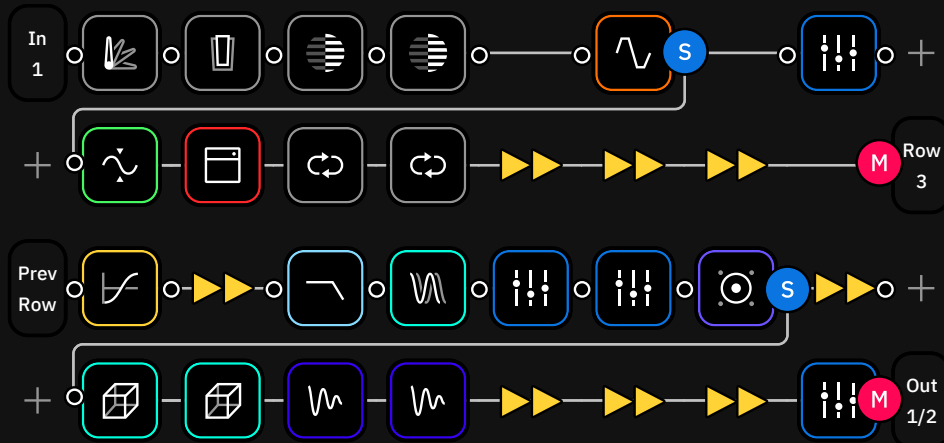

- This giant Preset includes almost all types of device blocks.
- Balance or A/B Splitters work with similar results. Muting “LEVEL TO A” or turning “Balance” all the way up will route the signal through the next row.
- In order to chain Rows 2 and 3, tap the output block in Row 2, and select Row 3 as the output. Row 3 input will be named as “**Prev. Row**” automatically.
- The second Splitter/Mixer path works the same way as before.
- If you want to make a Preset like this, we recommend taking a look at the **CPU Monitor** in order to check your CPU performance.

Check the [CPU Monitor](#) section for more details.

Using External IR files

Using your own IR files is also possible on Quad Cortex. Tap on a cab block to open its parameters.



For more details on how to import Impulse Responses, check the [Uploading Impulse Responses](#) section.

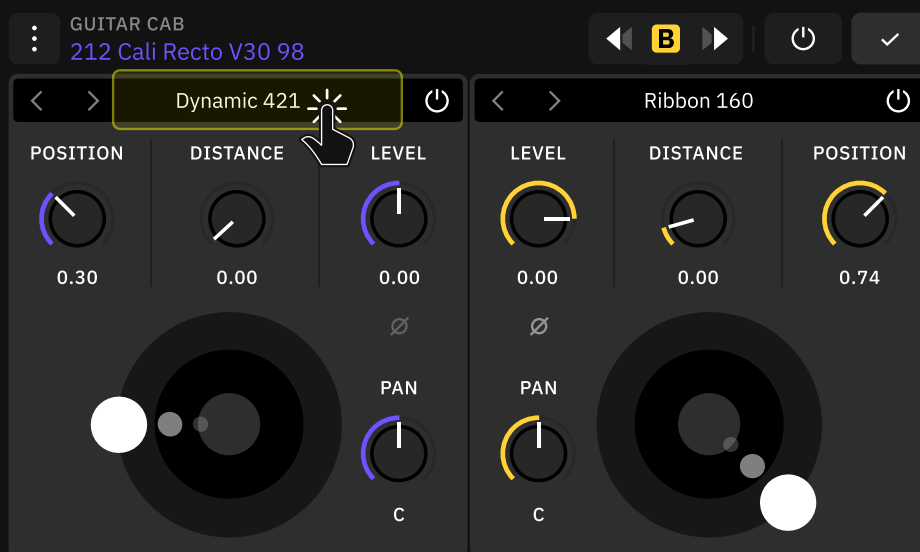

Tap on the Impulse selector box to open the drop-down menu. Scroll down and tap “**Load IR**”.

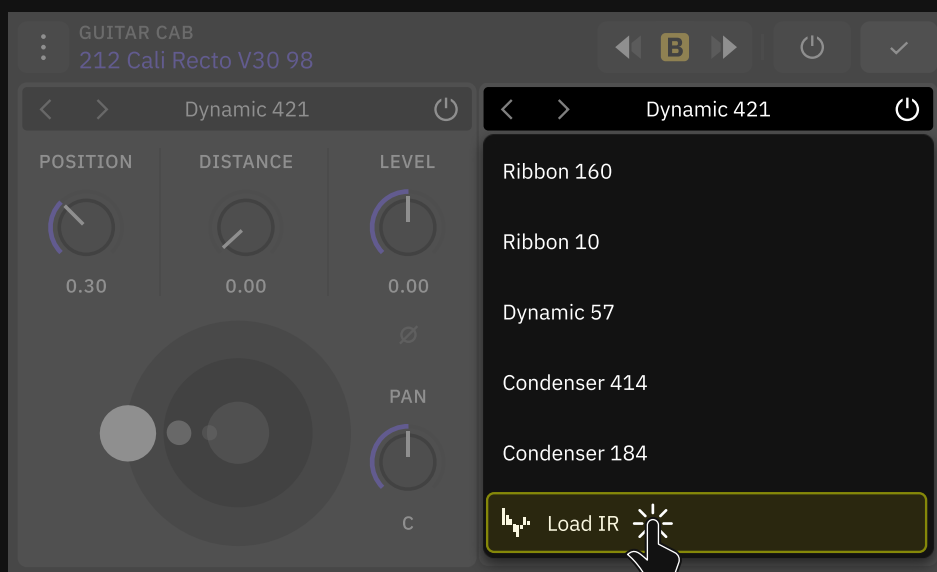

— Impulse Response Library

Here you can find all the IR files you have in the “**Impulse Responses**” folder.

Looper X

On the Quad Cortex, the Looper is a dedicated device block. The Looper X block can be placed anywhere on The Grid allowing for creative routing configuration and it can be used across all modes (*Preset, Scene, and Stomp*).

Tap the **Looper X block** to access its interface.

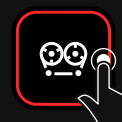

— Perform Mode

Use Perform mode to control the Looper X. All the controls are conveniently laid out and linked to the Quad Cortex footswitches already. You can always use the touchscreen.



- **DUPLICATE:** Creates an overdub that is X times longer than your original loop, allowing you to extend your original loop when recording an overdub. It arms the looper for recording if the Threshold function is enabled.
- **RE-LOOP:** Trim the length of your loop. This function is only available when DUPLICATE is active.
- **ONE SHOT:** Plays the loop once and then stops. Using ONE SHOT while playing a loop stops the playback when the recorded audio ends.
- **HALF SPEED:** Play the loop at half speed.
- **PUNCH IN:** Replaces the audio. Use it again to stop recording (PUNCH OUT).

- **RECORD**: Starts recording. It arms the looper for recording if the threshold function is enabled. This control is called OVERDUB during playback.
- **OVERDUB**: Starts recording during playback. The recorded signal is added on top of the existing recorded audio. This allows you to layer additional parts into a loop to create a more complex result.
- **PLAY**: Starts/Stops the playback.
- **REVERSE**: Rewinds the loop during playback. Using REVERSE before playback will start the loop backward after pressing PLAY.
- **UNDO**: Undo the last action. This control is called REDO after use. The REDO function restores any actions that were previously undone using UNDO.

— Params Mode

Use Params mode to access the Looper X settings. The controls are organized in three pages and linked to the Quad Cortex upper encoders. You can always use the touchscreen.

PAGE 1

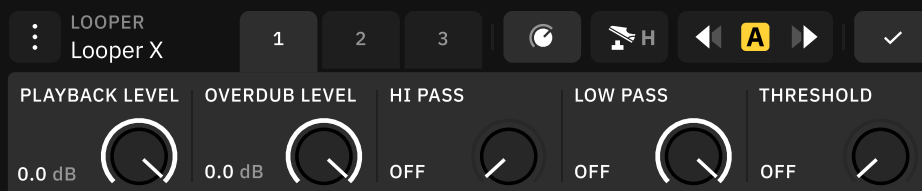

- **PLAYBACK LEVEL** KNOB: Adjusts looper playback level.
- **OVERDUB LEVEL** KNOB: Sets the level of your loop while overdubbing. For example, if the overdub level is set to -5dB, its volume will be reduced by -5dB each time the loop repeats, sounding quieter with each overdub take.
- **HIGH PASS** KNOB: Allows high frequencies to pass through while filtering or cutting low frequencies of the playback.
- **LOW PASS** KNOB: Allows low frequencies to pass through while filtering or cutting high frequencies of the playback.
- **THRESHOLD** KNOB: Allows the recording function to trigger when an audio signal is detected. This function will be disabled when the Looper X is receiving MIDI clock.

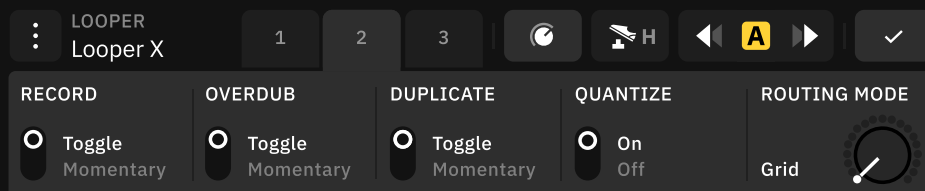
PAGE 2

- **RECORD MODE SWITCH:** Sets the RECORD function to Toggle or Momentary. In Momentary mode, the looper will record as long as the Footswitch E is held down.
- **OVERDUB MODE SWITCH:** Sets the OVERDUB function to Toggle or Momentary. In Momentary mode, the looper will record as long as the Footswitch E is held down.
- **DUPLICATE MODE SWITCH:** Determines whether the DUPLICATE function is synced or not to the current Tempo. When synced, the length of the loops will be fixed to the beat.
- **PUNCH MODE SWITCH:** Sets the PUNCH IN/OUT function to Toggle or Momentary. In Momentary mode, the looper will record as long as the Footswitch D is held down.
- **ROUTING MODE KNOB:** Allows you to configure the Input and Output routing. This can transform the Looper X from a Grid-based looper to Global I/O looper. **Check the next page for details.**

Routing Modes

GRID	The input and output signal of the Looper X will depend on its place in The Grid.
In1	Virtually places the looper in the Input block 1. The Looper X will receive input signal from the Input 1 and its output will be affected by any Row assigned to this input block.
In2	Virtually places the looper in the Input block 2. The Looper X will receive input signal from the Input 2 and its output will be affected by any Row assigned to this input block.
Ret1	Virtually places the looper in the Return 1. The Looper X will receive input signal from the Return 1 and its output will be affected by any Row or FX Loop block assigned to this input.
Ret2	Virtually places the looper in the Return 2. The Looper X will receive input signal from the Return 2 and its output will be affected by any Row or FX Loop block assigned to this input.
In1/2	Virtually places the looper in the Input blocks 1/2. The Looper X will receive input signal from both Inputs 1/2 and its output will be affected by any Row assigned to these input blocks.
Ret1/2	Virtually places the looper in the Returns 1/2. The Looper X will receive input signal from both Returns 1/2 and its output will be affected by any Row or FX Loop block assigned to these inputs.
Out1	Virtually places the looper in the Output block 1. The Looper X will receive input signal from Rows using the Output block 1.
Out2	Virtually places the looper in the Output block 2. The Looper X will receive input signal from Rows using the Output block 2.
Out3	Virtually places the looper in the Output block 3. The Looper X will receive input signal from Rows using the Output block 3.
Out4	Virtually places the looper in the Output block 4. The Looper X will receive input signal from Rows using the Output block 4.
Out1/2	Virtually places the looper in the Output blocks 1/2. The Looper X will receive input signal from Rows using the Output blocks 1/2.
Out3/4	Virtually places the looper in the Output blocks 3/4. The Looper X will receive input signal from Rows using the Output blocks 3/4.
Multi	Virtually places the looper in the Multi Out Block. The Looper X will receive input signal from Rows using the Multi Out block.

PAGE 3

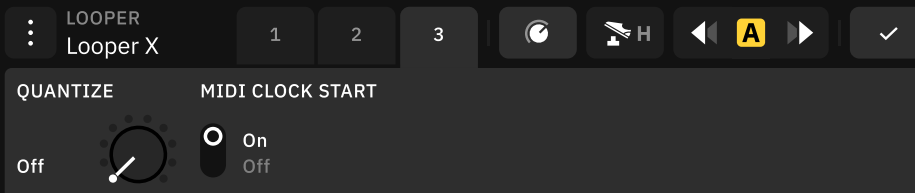

- **QUANTIZE KNOB:** Syncs the looper to Quad Cortex's Tempo or to an external MIDI clock. Select the number of beats to quantize according to the time signature used.
- **MIDI CLOCK START KNOB:** Controls whether the RECORD, DUPLICATE, and PLAY functions are started when it receives a MIDI clock start. When enabled, it overrides the Threshold feature.

How do I find the Looper X?

The Looper is a dedicated **device block**. Tap an empty space on The Grid, select the Looper section then you will find the Looper X.

How much looping time does the Looper X have?

You can record up to **4 minutes and 44 seconds**.

Does the Looper X stop when switching presets?

An active loop is persistent through Preset changes as long as the Preset you are changing to also vhas a Looper block added.

Can the Looper X parameters be controlled by MIDI?

Yes, Looper X parameters can be controlled via specific reserved CC messages. More information on [page 93](#).

Device Blocks Parameters

Quad Cortex features multiple device block types, each of them with their own parameters and dedicated controls.

— Amp Parameters



PARAMETER	DESCRIPTION
GAIN	Controls the amount of gain in the preamp section.
VOLUME	Controls the amount of volume in the preamp section.
BASS/MID/TREBLE	Tonestack of the amp. 3 band EQ.
MASTER	Adjusts the amount of power amp gain. This parameter is highly interactive with all other amp parameters. The lower the Master is set, the less effect the other controls will have.
PRESENCE	Boosts the upper midrange and treble frequencies.
DEPTH	Boosts the lower midrange and bass frequencies.
RESONANCE	Boosts the bass frequencies.
BRIGHT	The treble is further enhanced with this switch.
OUTPUT	Controls the overall volume of the amp.
SWITCHES	Many amps feature custom switches to control their unique parameters. Tap them to modify their value.
FINE CONTROL	Tap a knob value to set a custom value. Use the touch keyboard and tap “Set” to save the changes.
BYPASS	Bypasses the block entirely.

— Cab Parameters

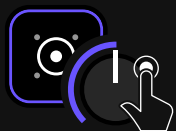

PARAMETER	DESCRIPTION
NAVIGATION ARROWS	Tap to navigate through the different impulses.
IMPULSE SELECTOR BOX	Tap the impulse name to reveal the drop-down menu for selecting factory impulses and loading your own IR files.
POWER BUTTON	Enables or disables the respective IR loader section.
POSITION	Controls where the microphone is, from the center of the cone to the edge of the cone (<i>automatically disabled when using external IR files</i>).
DISTANCE	Controls the distance of the mic between close to the cab and far towards the room (<i>automatically disabled when using external IR files</i>).
LEVEL	Controls the level volume of the selected impulse.
PAN	Controls the output panning of the selected impulse.
PHASE INVERTER	Inverts the phase of the loaded impulse.
CABINET DISPLAY	Drag the white circle around to interact with the mic position. This action will be reflected in the POSITION and DISTANCE parameters.
BYPASS	This button bypasses the block entirely.

EQ Parameters



PARAMETER	DESCRIPTION
GAIN	Controls the gain of the selected band.
FREQ	Sets the frequency of the selected band.
Q	Attenuate or boost a very narrow or wide range of frequencies within a single band.
+ / -	Toggles the band on/off (<i>8 bands available</i>).
BAND TYPES	Tap them to highlight the band circles accordingly. Tap and hold on a band to change the type (<i>Peak, Hi-Pass, Lo-Pass, Hi-Shelf, and Lo-Shelf</i>).
BAND CIRCLES	Once a band is enabled, you can drag it around the screen. This action will be reflected in the GAIN and FREQ parameters.
BYPASS	This button bypasses the device block entirely.
HPF	Allows high frequencies to pass through while filtering or cutting low frequencies.
OUTPUT	Controls the overall volume of the EQ.

— Common FX Parameters



PARAMETER	DESCRIPTION
GAIN	Controls the gain value of the selected device.
DRIVE / OVERDRIVE	Controls the drive value of the selected device.
TONE	Controls the treble frequencies. This parameter can let all the treble frequencies through or cuts a large amount of treble and some high mids.
VOLUME	Sets the overall volume of the selected device.
COMP	The amount of gain reduction is determined by this parameter.
THRESHOLD	Sets the level at which the main parameter operates.
RATE	Adjusts the rate of the effect, with higher settings providing faster rates.
DEPTH	Sets the intensity of the modulation.
SYNC	Allows you to sync effects to the current Quad Cortex Tempo. The Sync Note value is constrained by the Tempo and the Speed parameter range.
FEEDBACK / MIX / BLEND	Adjusts the amount of delayed signal fed back into the effect. The higher the settings, the wetter the signal is.
DECAY	Determines the length of time the effect sustains.
PRE DELAY	Sets the time before the effect is heard.
HIGH / LOW PASS	Controls the frequency range of the high and low pass filters.
TRAILS SWITCH	Trails Off: Any delay or reverb effect is instantly muted when the block is bypassed. Trails On: Any delay or reverb effect decay naturally when the block is bypassed.
BYPASS	This button bypasses the block entirely.

05

Modes

Quad Cortex features three modes to give ultimate control over features and footswitch customization, **Stomp Mode**, **Scene Mode**, and **Preset Mode**. You will have access to further customization options depending on the mode you select.

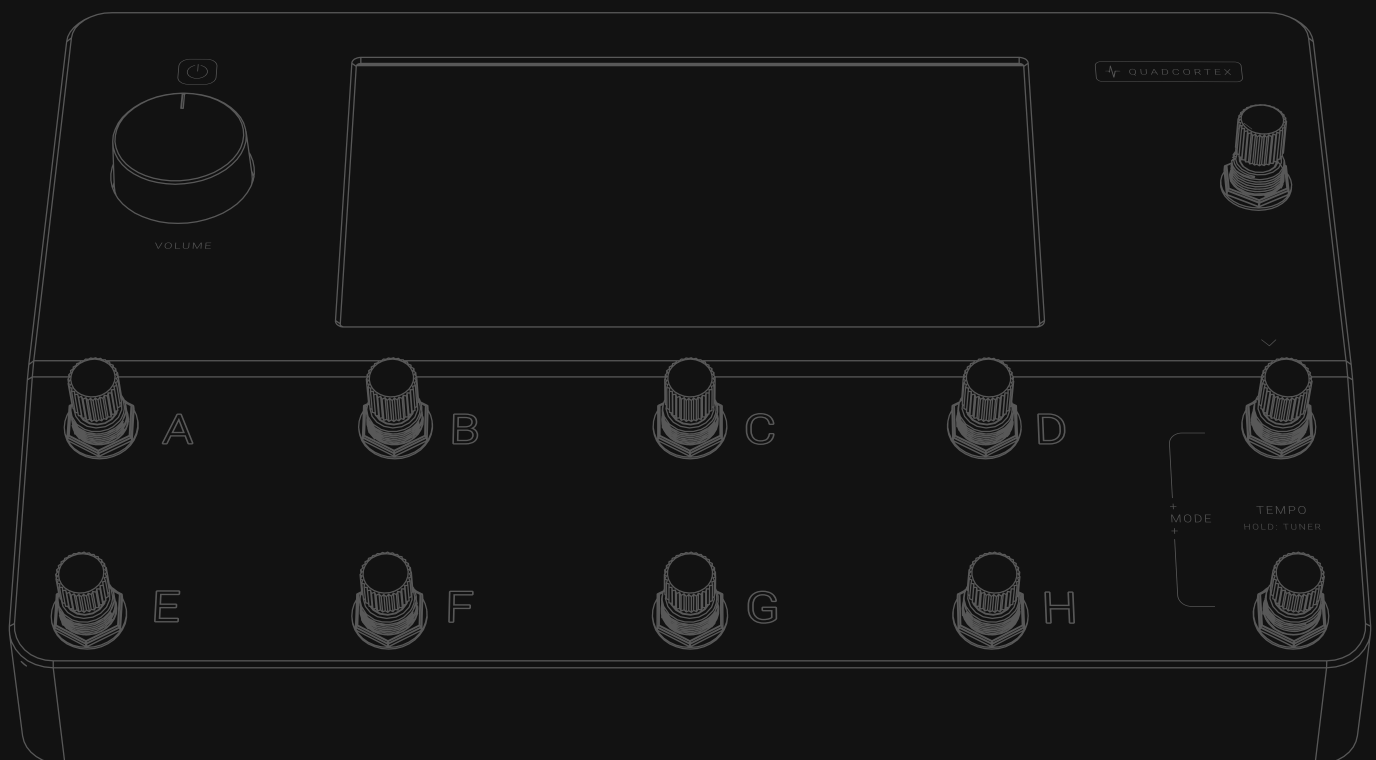

Switching Modes

You can switch between modes by tapping the name of the mode currently active at the top-right of The Grid, or by pressing the furthest-right footswitches on the bottom two rows together.

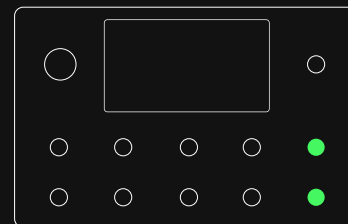

Preset Mode

Preset Mode enables you to have eight completely different rigs.

Press the **A to H footswitches** to navigate through the Presets.

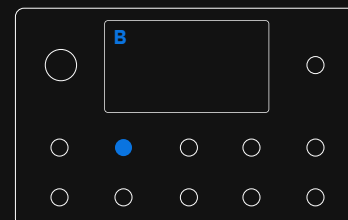

Navigating through Banks

Press the Up and Down footswitches to navigate through banks of Presets in your Setlist.

The bank number and Preset name will change immediately after you press the up or down footswitches. The Preset name and active footswitch will also blink intermittently. To confirm the change, press the blinking footswitch again.

If you want to load another Preset in the new bank instead, press the corresponding footswitch twice.

To cancel the whole operation, press the TEMPO footswitch (**red LED**).

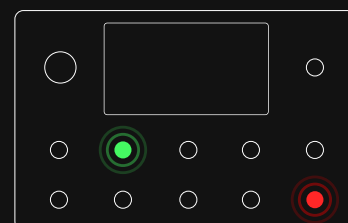
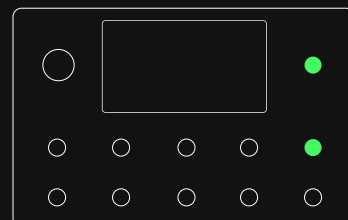

Scene Mode

Scene Mode allows you to control the settings of any number of blocks in a rig.

Press the footswitches to navigate through the different Scenes. You can see the currently active Scene as a **letter block** in the upper-right corner. **Tap-and-hold** a parameter to assign it to Scenes **A B C D**. Scene parameter assignment/changes can be performed regardless of the current active Mode.

A B C D SCENE

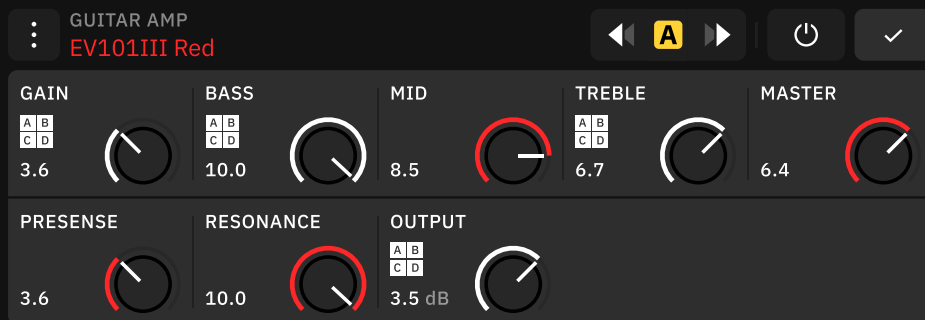
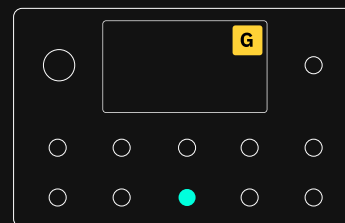

Tap-and-hold a Scene-assigned parameter to prompt the unassign dialog. Removing the assignment will restore the value from the main Scene.

Scene A is the default Scene of any new Preset. To change a Preset's default Scene, just save the Preset with another Scene loaded.

Preset Grid

Preset 4E - Scene A

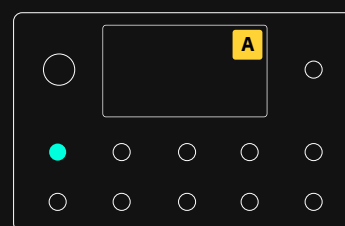

Preset 4E - Scene B

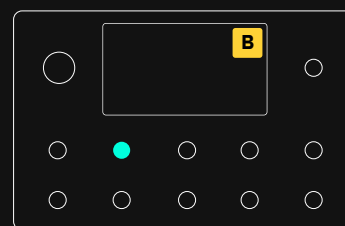

Preset 4E - Scene C

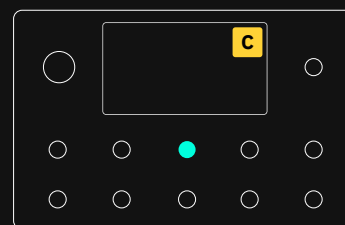

In the first example, **Scene A (Footswitch A)** bypasses the compressor, drive, and reverb blocks for a dry rhythm tone. **Scene B (Footswitch B)** toggles the compressor and drive but leaves the reverb pedal bypassed. **Scene C (Footswitch C)** engages all the blocks in the row for a soaring lead guitar tone.

The parameters within each virtual device can also be changed in each Scene.

Footswitch LEDs

The footswitch LEDs will illuminate according to the selected Scene. Eight scenes are available for each Preset.



Navigating through Presets

While using Scene mode, **press the Up and Down footswitches** to navigate through Presets.

Press and hold either the **Up** or **Down footswitch** to navigate through banks. The Preset name and active footswitch will also blink intermittently. To confirm the change, press the blinking footswitch.

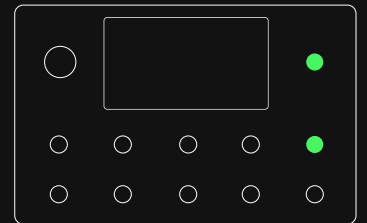

Copy & Paste Scenes

Scenes can be copied and pasted into different footswitches via the main menu on The Grid. This action can be performed in any mode.

If you want to cancel the whole operation, tap the CANCEL button.

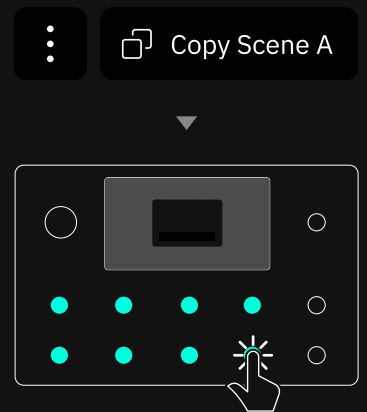

Swap Scenes

Scenes can be swapped via the main menu on The Grid. This action can be performed in any mode.

If you want to cancel the whole operation, tap the CANCEL button.

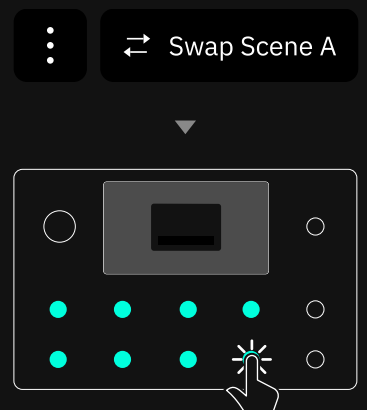

Stomp Mode



Stomp Mode allows you to assign any block in a rig to a footswitch, just like you would with an analog pedalboard.

In Stomp Mode, blocks get automatically assigned to footswitches in the order they are added to The Grid.

Multiple devices can be assigned to one footswitch. There is no limit to the number of devices' bypass status that can be assigned to a single footswitch.

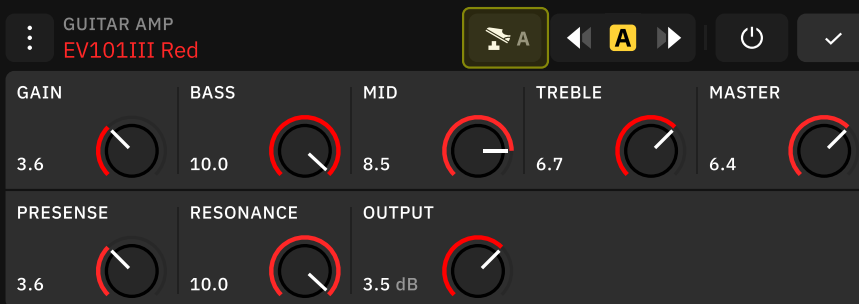

Tap to allocate the block to a different footswitch.

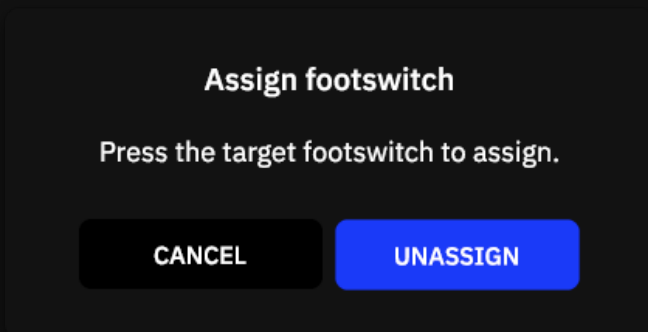

Tap to unassign the block from its current footswitch.

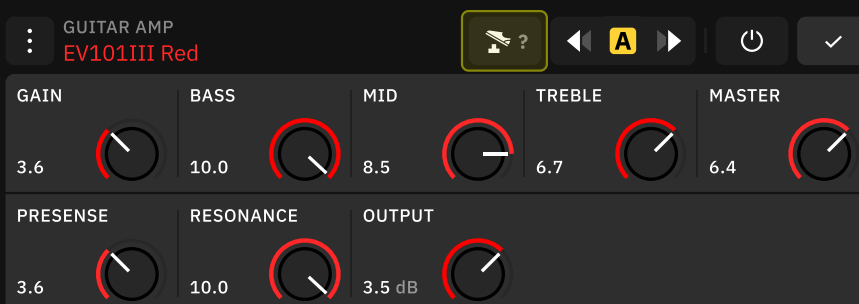

Tap to assign an unassigned block to a footswitch.

In the following example, you can see five device blocks assigned to different footswitches. Press the footswitches to engage or disengage the blocks.



* Letter-circles are not part of the actual Quad Cortex display.

Multiple devices can be assigned to one footswitch.
 There is no limit to the number of devices' bypass status that can be assigned to a single footswitch.

Footswitch LEDs

Once a block is assigned to a footswitch, the LED will illuminate corresponding to the color of the assigned block.

The first eight blocks created in the Preset will be assigned to footswitches automatically. If your Preset has more than eight blocks, you have to assign the ones you want to control manually.

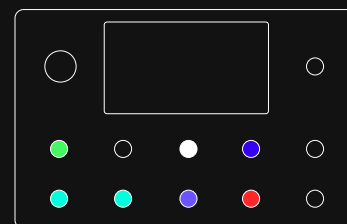

Navigating through Presets

While using Stomp mode, **press** the **Up** and **Down** footswitches to navigate through Presets.

Press and hold either the **Up** or **Down** footswitch to navigate through banks. The Preset name and active footswitch will also blink intermittently. To confirm the change, press the blinking footswitch.

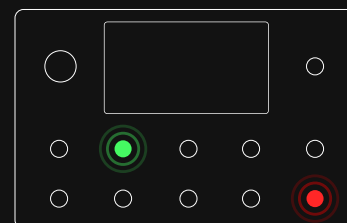
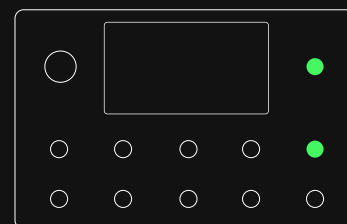

Gig View

Gig View allows you to visualize what the footswitches are assigned to instantly. This visualization utilizes the entire screen.

Access Gig View by swiping up from the bottom of The Grid.

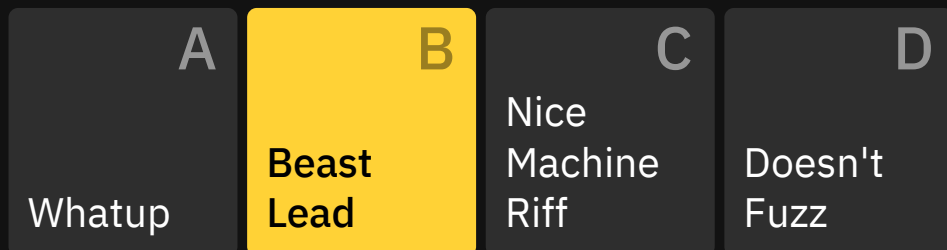

Preset Mode: Gig View shows you the Preset assigned to each footswitch. Tap the active footswitch a second time to show an enlarged view of the current Preset.

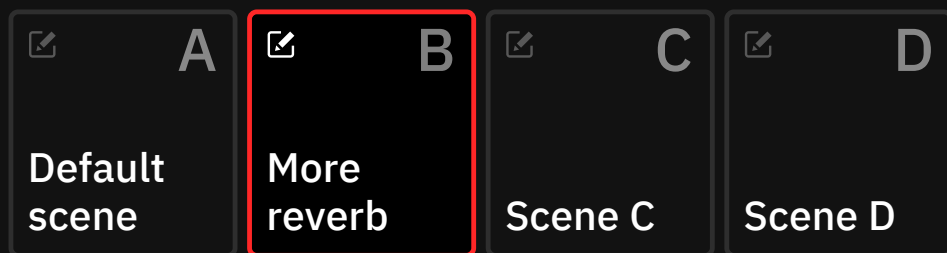

Scene Mode: Gig View shows you the Scene assigned to each footswitch. You can change the names of your Scenes. Tap the edit icon in the upper-left corner of the Scene blocks to create/change Scene names.

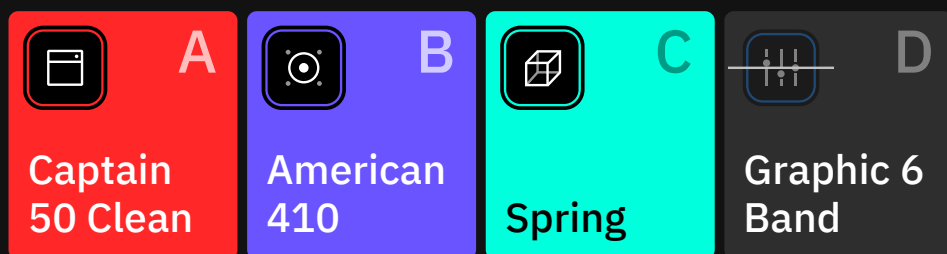

Stomp Mode: Gig View shows you the device assigned to each footswitch.

Tap the “Close” button to get back to **The Grid**.

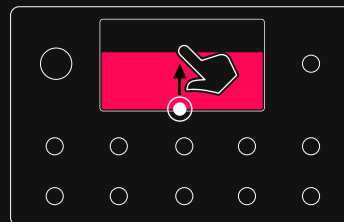

While in Gig view, tap the Mode name at the top-right corner or press the furthest-right footswitches on the bottom two rows together to **change Modes**.

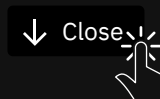
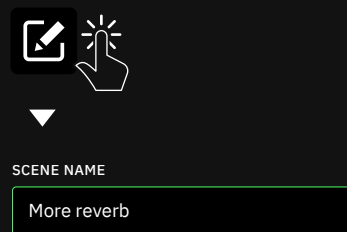
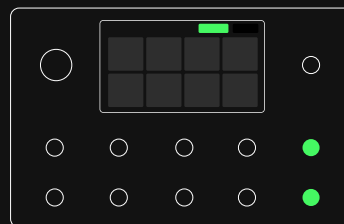

06

Setup Examples

This section provides an overview of various ways to use Quad Cortex. These diagrams and Preset examples represent just a few of the many ways to use the unit.

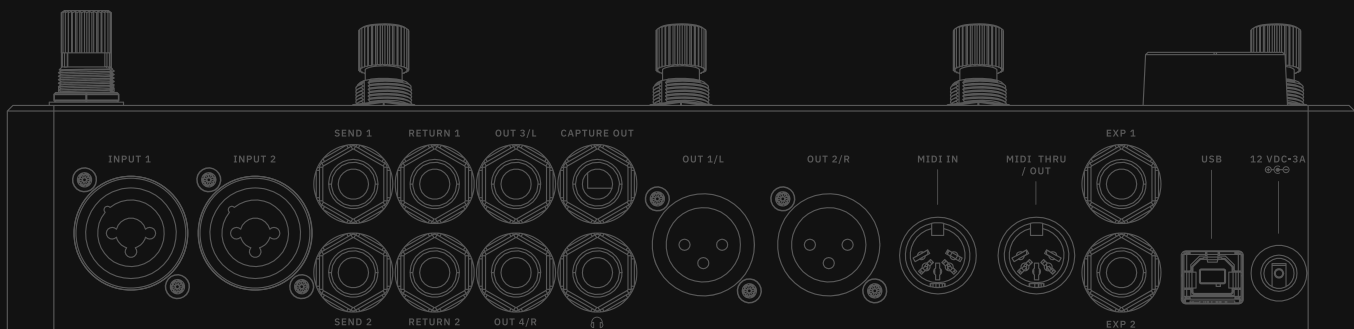

Basic Routing

Quad Cortex offers multiple routing options, which can be configured through the **I/O Settings** screen.

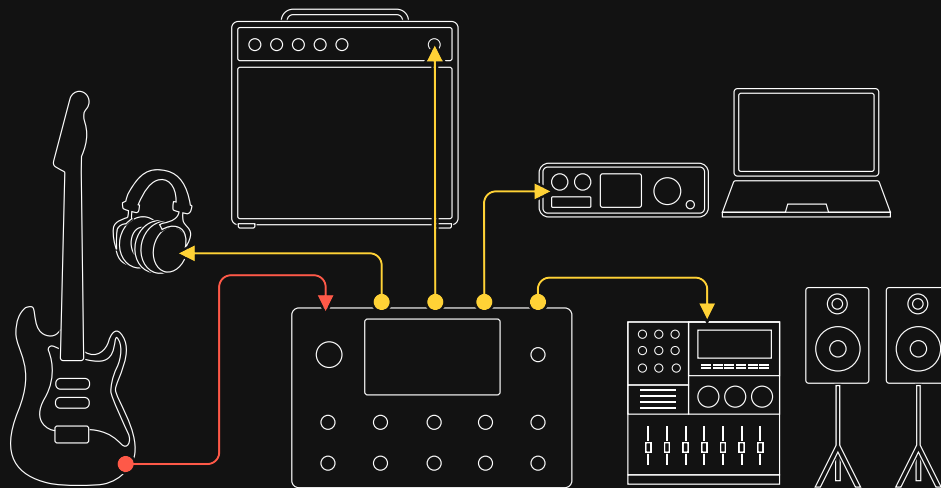

Most signals will begin with an instrument. Factory Presets and newly created Presets will use **In 1** and **Multi-Output** blocks by default. The Multi-Out block routes your signal through XLR Outs 1/2 as well as TRS Outs 3/4, and USB. You can use this routing as a multi-purpose set up to monitor your signal while you're playing. However, you can use the headphone out of the unit to keep things even simpler:

1. Connect your instrument to **Input 1**.
2. Connect your headphones to the **Headphone** output.
3. Adjust the mix on the **I/O Settings** screen.

I/O Setup

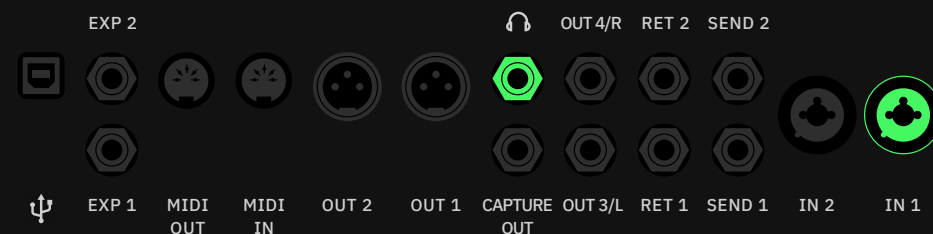

The outlined routing configurations can be used to connect to FRFR systems, audio interfaces, and many other setups.

The Multi-Out block routes your signal through XLR Outs 1/2 as well as TRS Outs 3/4, and USB. It's the default setting for all Factory Presets and newly created Presets.

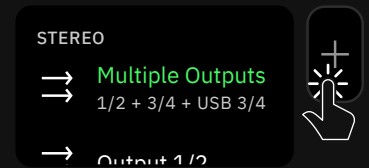

Tap any output block in The Grid then select "**Multiple Outputs**" to enable this feature.

FRFR/Direct

This type of setup is common for live applications, without needing to disable any device on the signal chain due to using a flat response system. You can use the same I/O setup to connect to an audio interface.

1. Connect your instrument to **Input 1**.
1. Connect **OUT1/L** (and **OUT2/R** if stereo) to an FRFR system or an audio interface using XLR cables.

I/O Setup #1

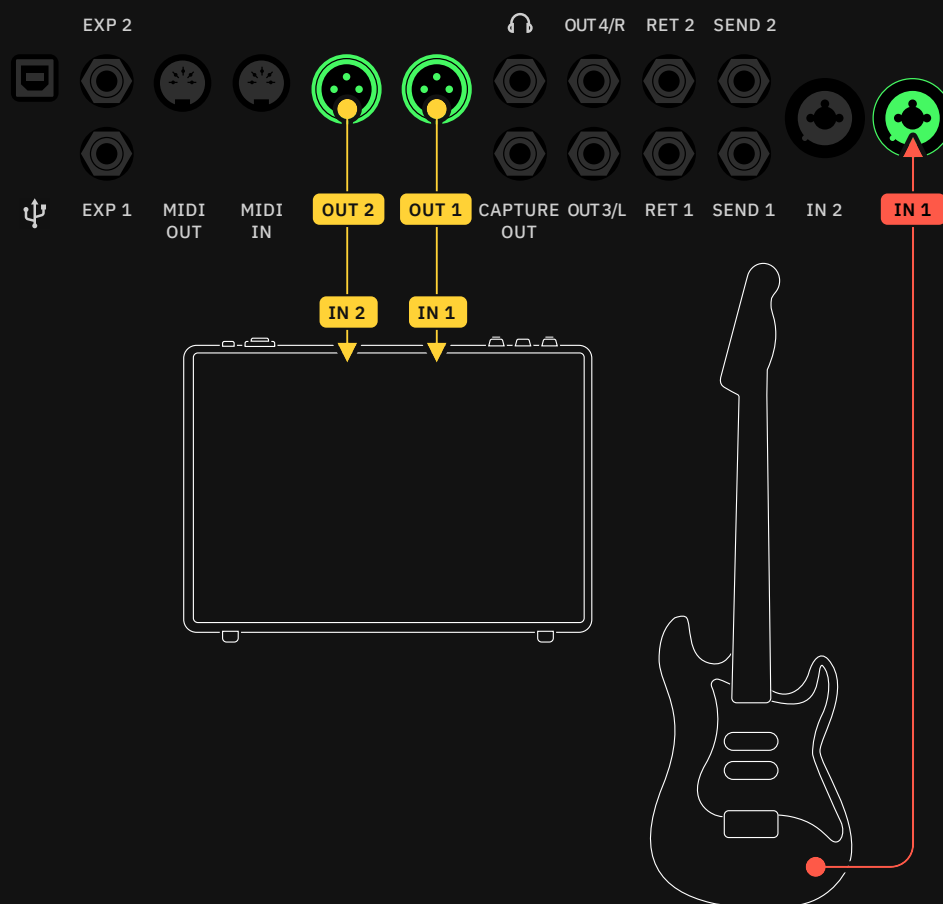

I/O Setup #2

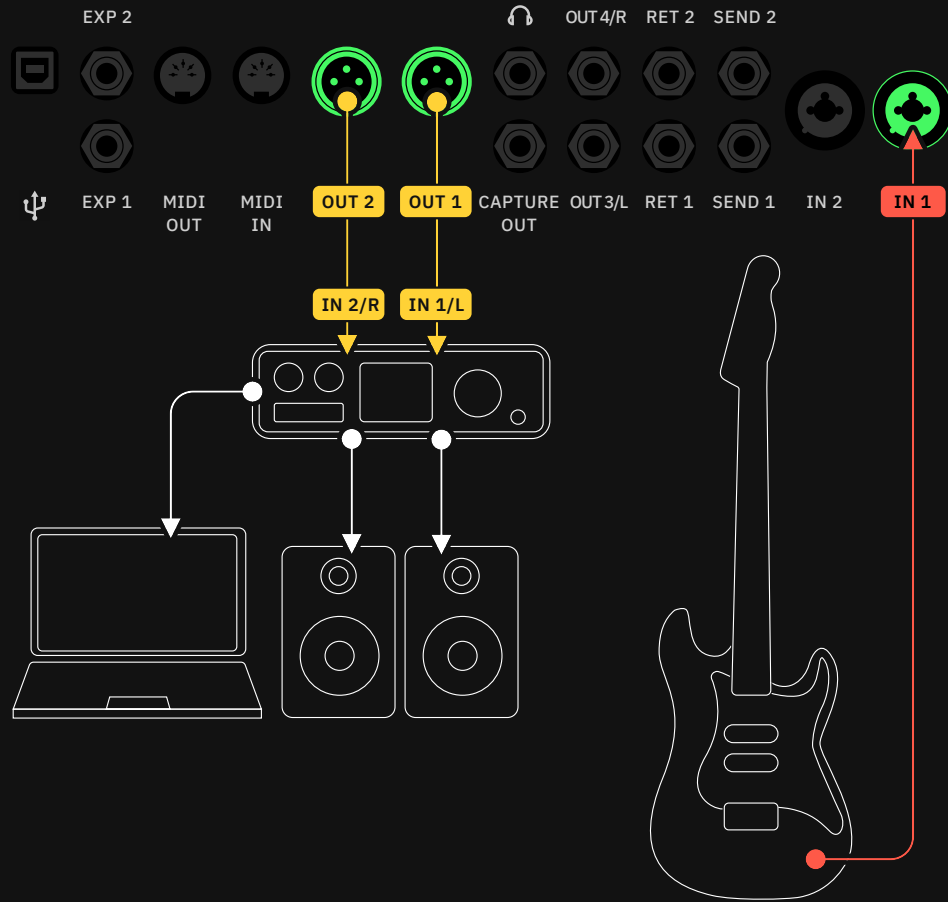

FRFR Monitor + FRFR to Front-of-House

This method is used to send a “copy” of the stereo signal to a mixing console or another monitoring system.

1. Connect your instrument to **Input 1**.
2. Connect **OUT1/L** and **OUT2/R** to an FRFR system.
3. Use The Grid to patch your signal chain to use Outputs 3 and 4 using an **A/B Splitter**.
4. Connect **OUT3/L** and **OUT4/R** to a mixing console or another monitoring system.

Why use an A/B Splitter?

Using an A/B Splitter allows you to send a custom amount of signal to each external device.

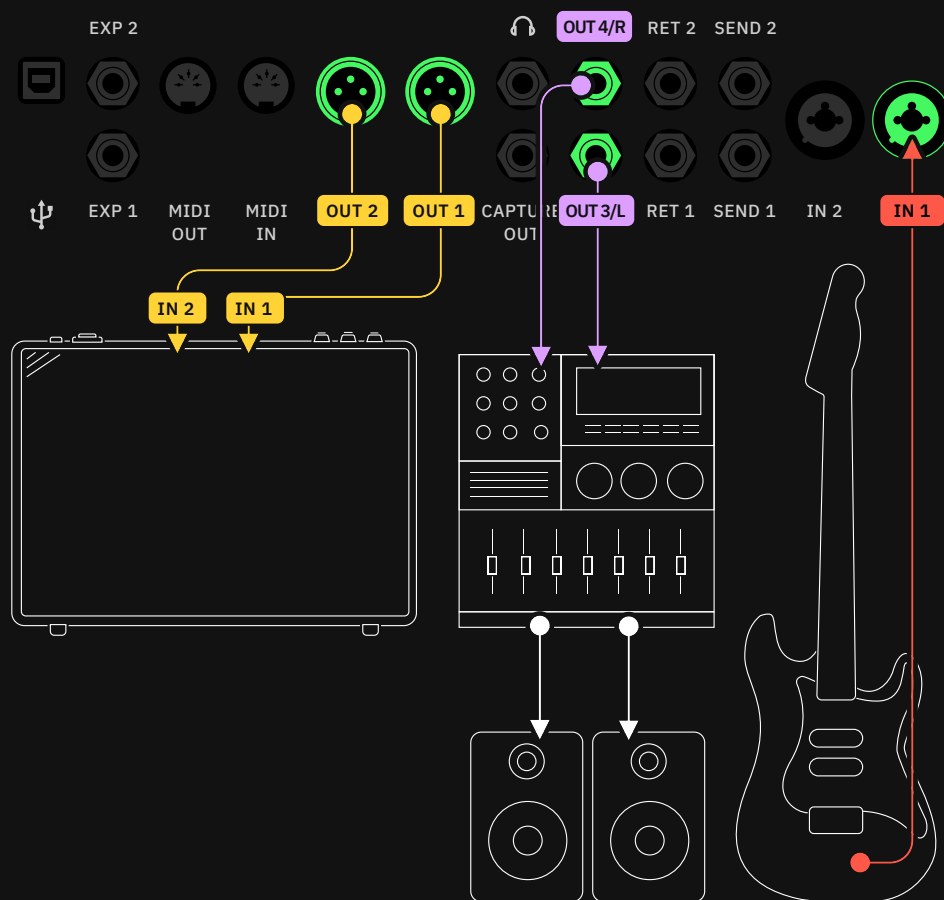

Preset Grid #1

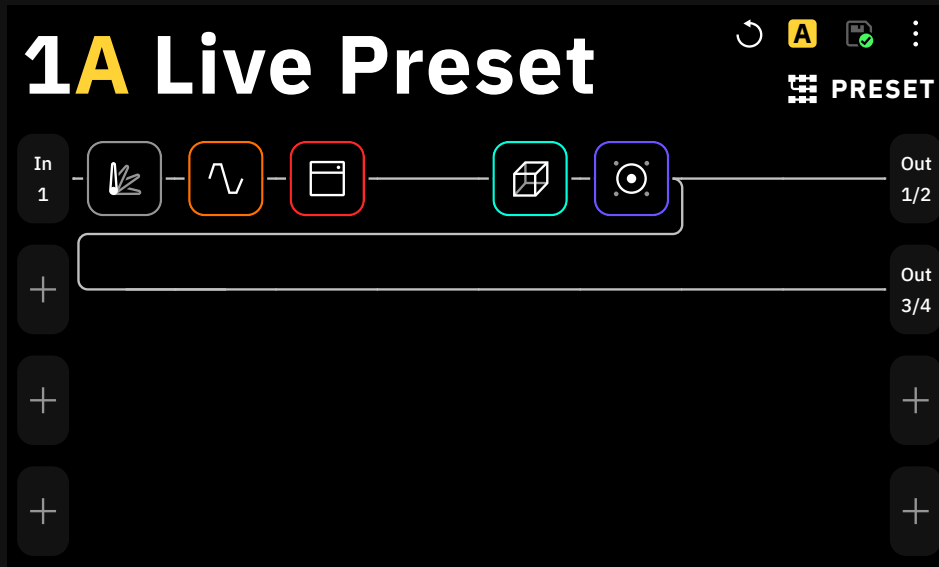

The Multi-Out block routes your signal through XLR Outs 1/2 as well as TRS Outs 3/4, and USB. It's the default setting for all Factory Presets and newly created Presets.

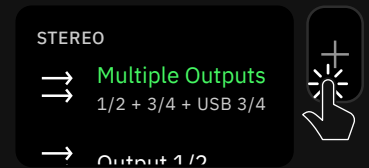

Tap any output block in The Grid then select “Multiple Outputs” to enable this feature.

Preset Grid #2

A simpler version of this setup is made by using only mono signals through outputs 1 and 2:

1. Connect your instrument to **Input 1**.
2. Connect **OUT1/L** to the primary FRFR system and the **OUT2/R** to the other system/mixing console.
3. Use The Grid to patch your signal chain to **Outputs 1** and **2** separately using an **A/B Splitter**.

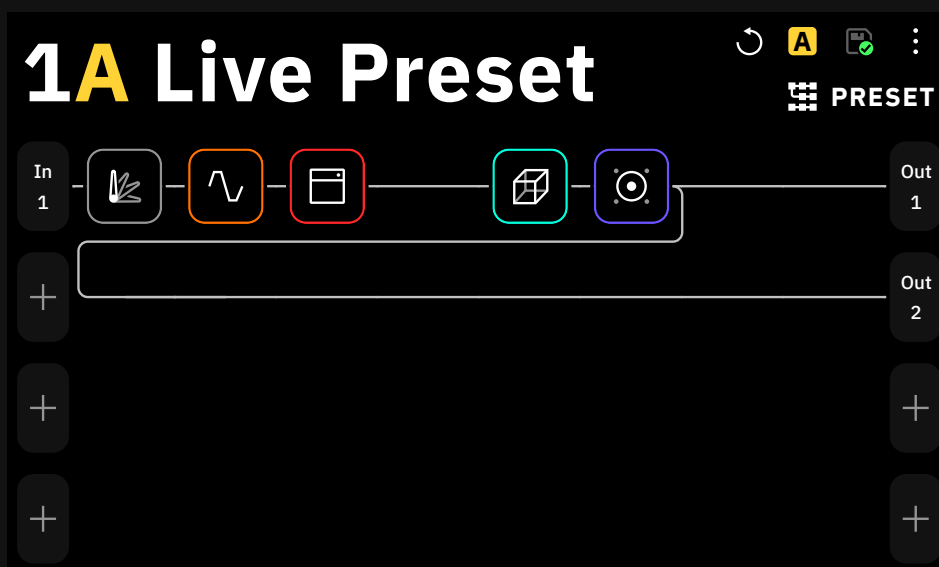

In both cases, make sure the **Splitter** is set to **A/B**.

Using an A/B splitter allows sending a custom amount of signal to the mixing console without affecting the level of the FRFR amplifier.

Combo Amplifier

This method requires you to bypass/turn off the Cab block on the Quad Cortex as you will use a real cabinet.

1. Connect your instrument to **Input 1**.
2. Use a 1/4" TS cable to connect Quad Cortex (**OUT3/L**) to the amplifier's input.
3. Don't add a Cab block in your Preset. If the Preset includes a Cab block, bypass it.

I/O Setup

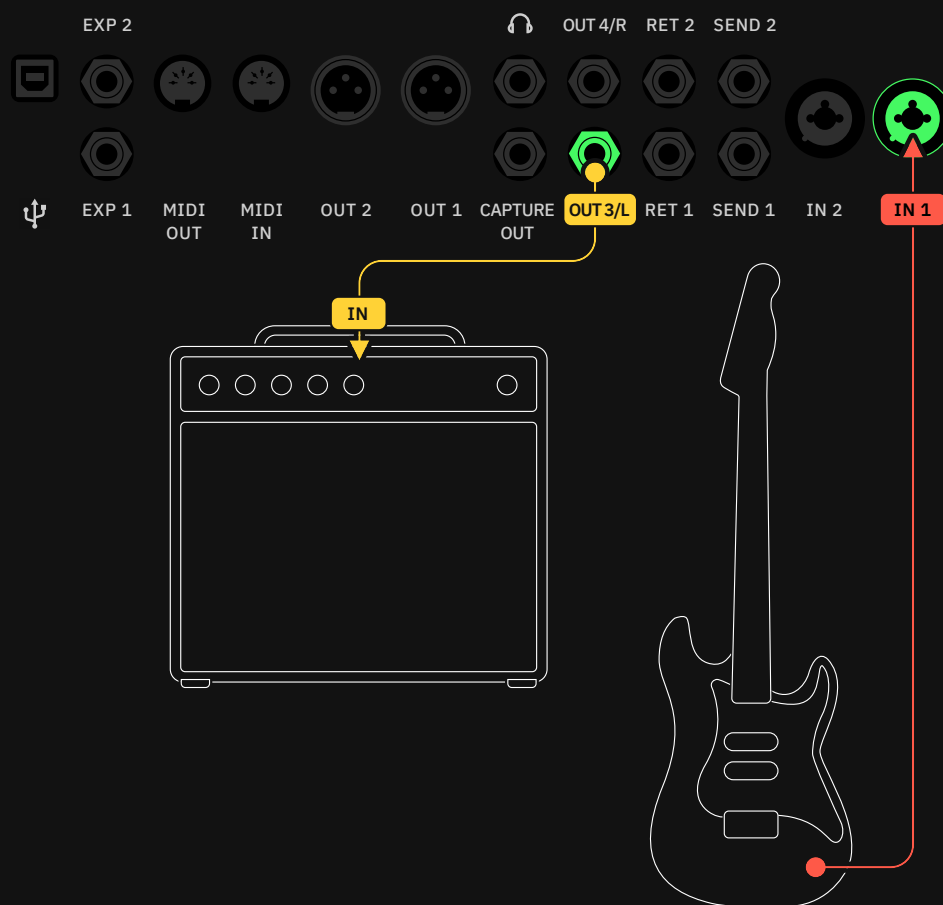

Preset Grid



Power Amp & Cab + FRFR/Direct

This method is used to maintain a full signal chain that can be sent to a flat response system while sending a parallel signal to a cabinet with the cab device bypassed on Quad Cortex.

1. Connect your instrument to **Input 1**.
2. On The Grid, make sure the main signal is going through outputs 1 and 2 (**OUT1/L** and **OUT2/R**). Then use an **A/B Splitter** to patch the signal before reaching the cab block to output 3 (**OUT3/L**).
3. Connect **OUT1/L** (and **OUT2/R** if stereo) to an FRFR system, and connect the **OUT3/L** to the power amp+cab setup.

The Multi-Out block routes your signal through XLR Outs 1/2 as well as TRS Outs 3/4, and USB. It's the default setting for all Factory Presets and newly created Presets.

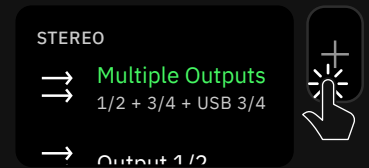

Tap any output block in The Grid then select “Multiple Outputs” to enable this feature.

I/O Setup

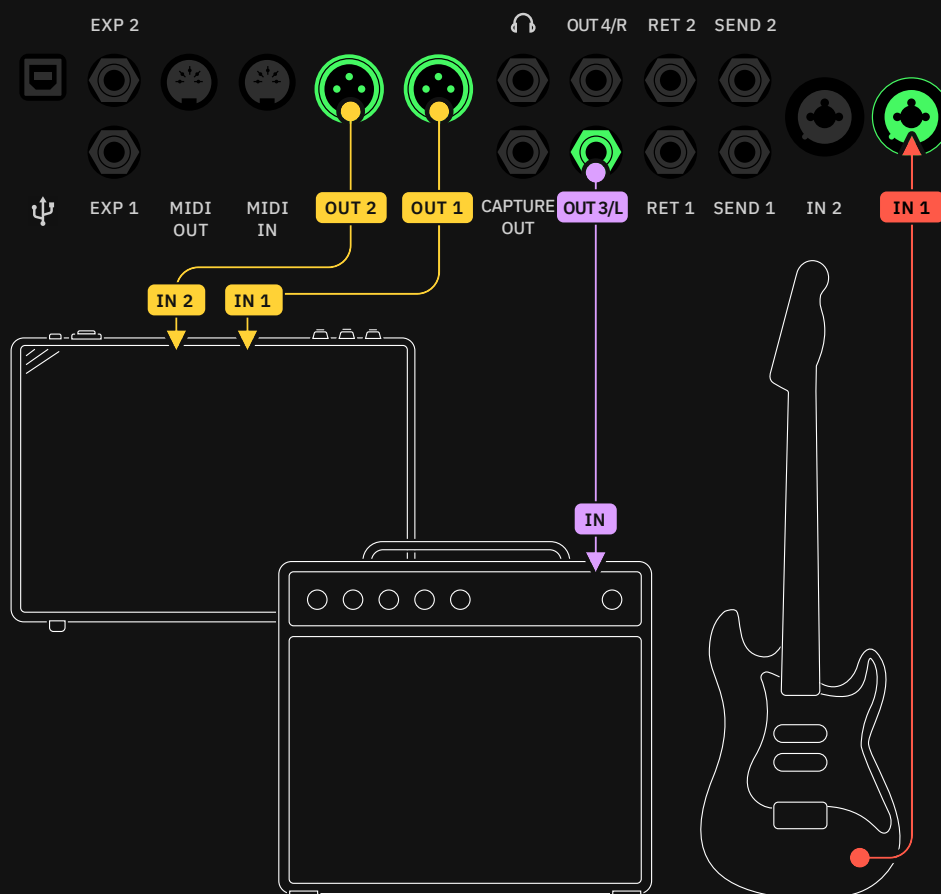

Preset Grid



Four Cable Method (4cm)

The four cable method allows you to use effects in different stages of the signal chain (pre and post) in conjunction with an amplifier and cabinet. The Quad Cortex will be used as an effects processor, therefore the Presets created for this purpose don't need amp or cab device blocks. This method allows you to place pre effects tools such as overdrives, noise gates, and pitch shifters before the amplifier. Post effects such as reverbs and delays will sound after the amp.

1. Add an FX Loop device block. Choose **FX Loop 1**.
2. Add device blocks before and after the FX Loop block.
3. Set the output block as **Out 3**.

You will need four TS cables for making the connections:

1. Connect your instrument to **INPUT 1**.
2. Connect **OUT 3/L** to the amplifier's FX return.
3. Connect **SEND 1** to the amplifier's input.
4. Connect **RETURN 1** to the amplifier's FX send.

I/O Setup

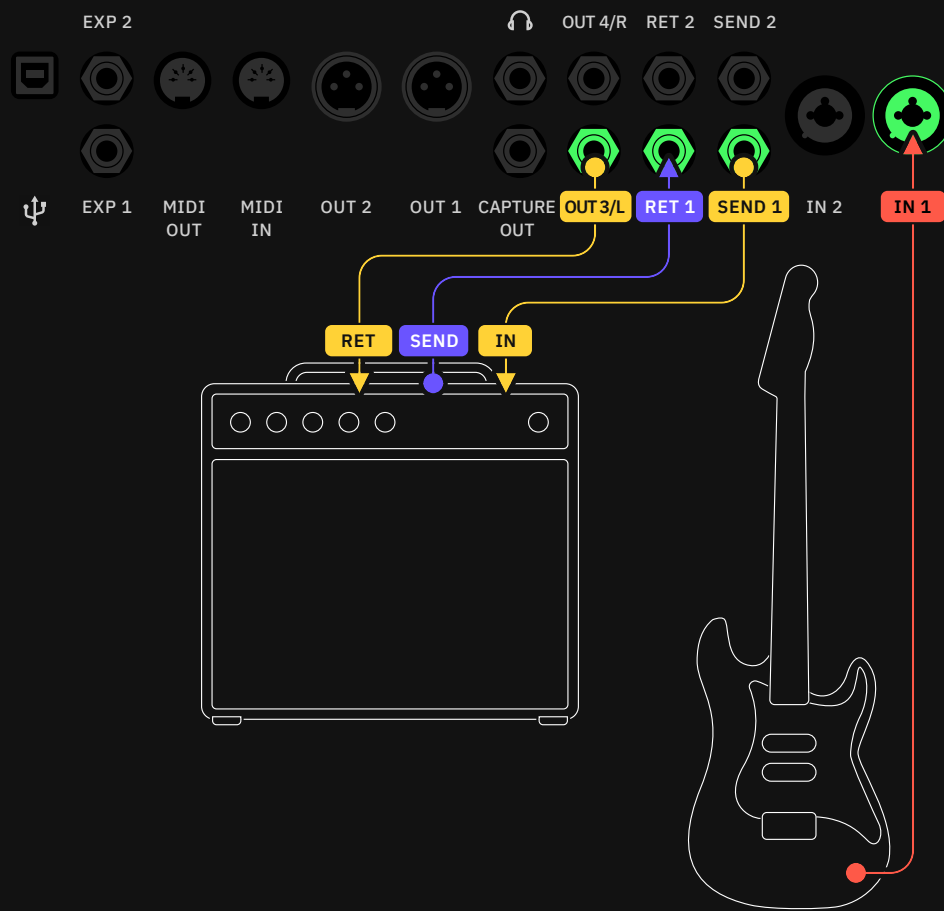

Preset Grid #1

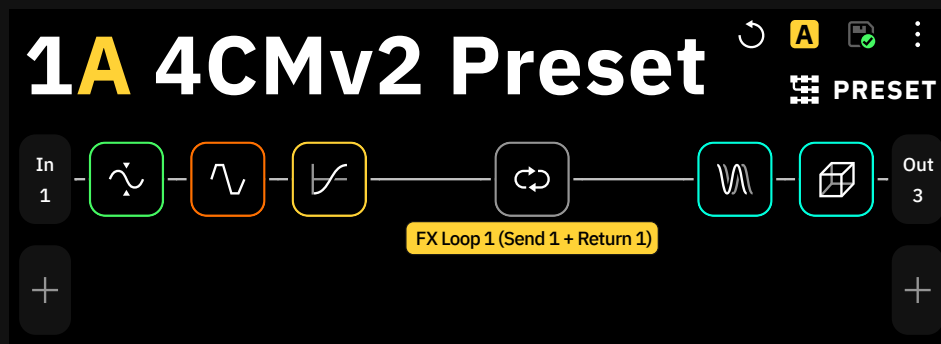

Why FX Loop 1?

There are many FX Loop devices. **FX Loop 1** takes the signal from the row where it's placed and returns it by using **SEND 1** and **RETURN 1**.

If you want to use **SEND 2** and **RETURN 2** for connecting your external devices, choose **FX LOOP 2**.

Seven Cable Method (7cm)

With the seven cable method, you can set two separate rows to use the effects included on the Quad Cortex with two external amplifiers.

1. Connect your instrument to **Input 1**.
2. Add all the pre effects blocks you want on the first row of The Grid.
3. Use an **A/B splitter** to route the signal to the second row.
4. Add an **FX Loop** block on Rows 1 and 2. The one on the first row must be set to **Send 1 | Return 1**, and the second one to **Send 2 | Return 2**.
5. Add post effects after the FX blocks. Set the outputs of each row to **Output 3** and **4** respectively.
6. Connect a cable from **Send 1** of the Quad Cortex to the instrument input on the first amp. Connect another cable from **Send 2** of the Quad Cortex to the instrument input on the second amp.
7. Connect the Effects Loop Sends from each amp to **Return 1 and 2** on the Quad Cortex.
8. Finally, connect **Outputs 3 and 4** of the Quad Cortex to the Effects Loop Return of each amp.

I/O Setup

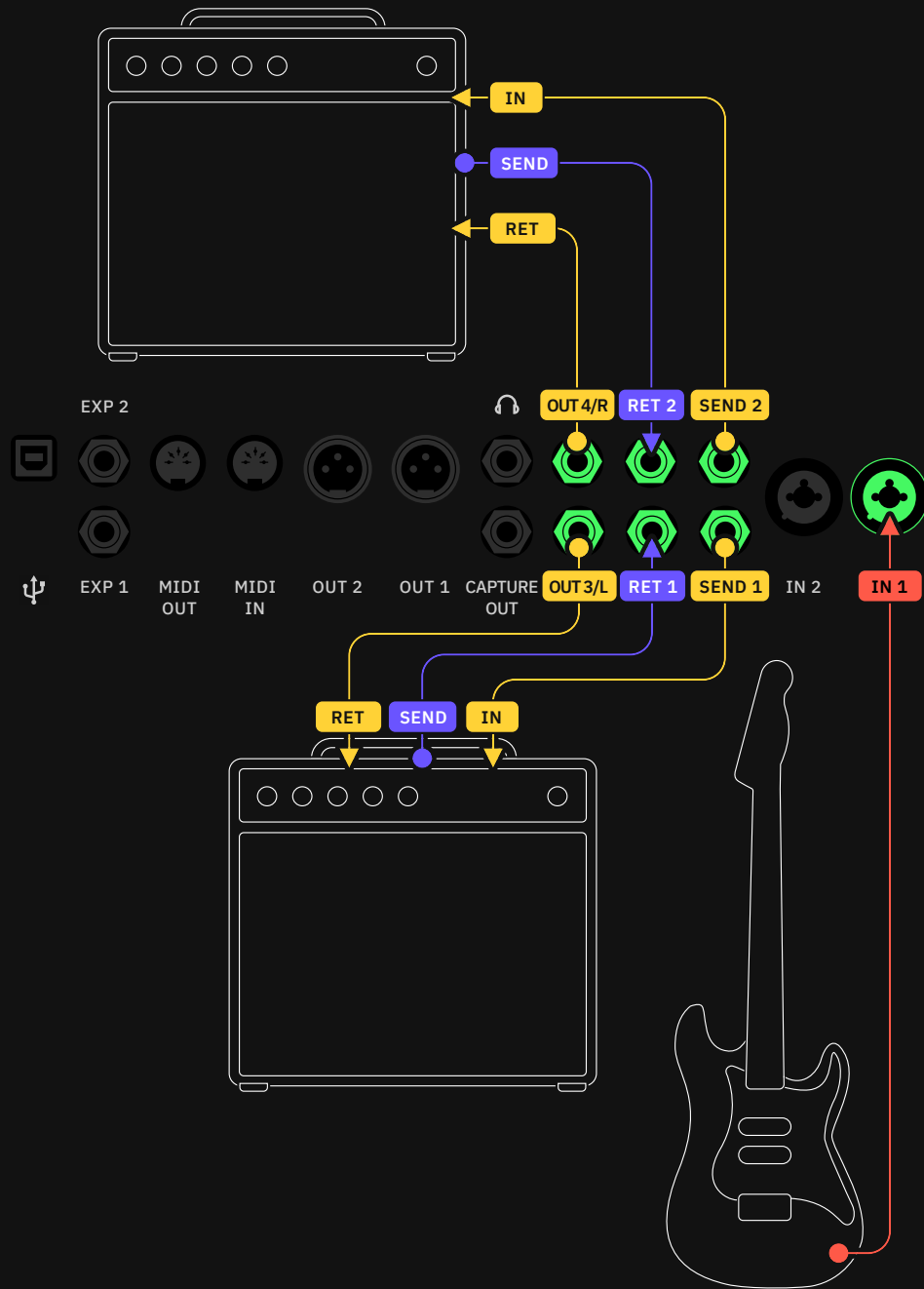

Preset Grid

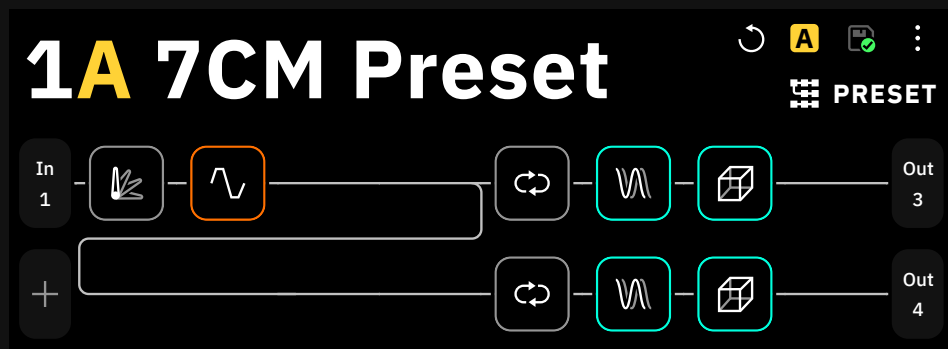

As FX Loop Only

The post effects included on Quad Cortex, like reverbs and delays, can be used independently through the FX loop of an external amplifier. For this purpose, your Presets will only contain one row of post effects blocks.

1. Connect your instrument to the input of your amplifier.
2. Connect an instrument cable from the **Send** of the FX Loop of the amplifier to **Input 1** on Quad Cortex.
3. On The Grid, add all the post effects you want to the first row and set the output to **OUT3/L**.
4. Connect the **OUT3/L** on the Quad Cortex to the **Return** of the amp's FX Loop.

I/O Setup

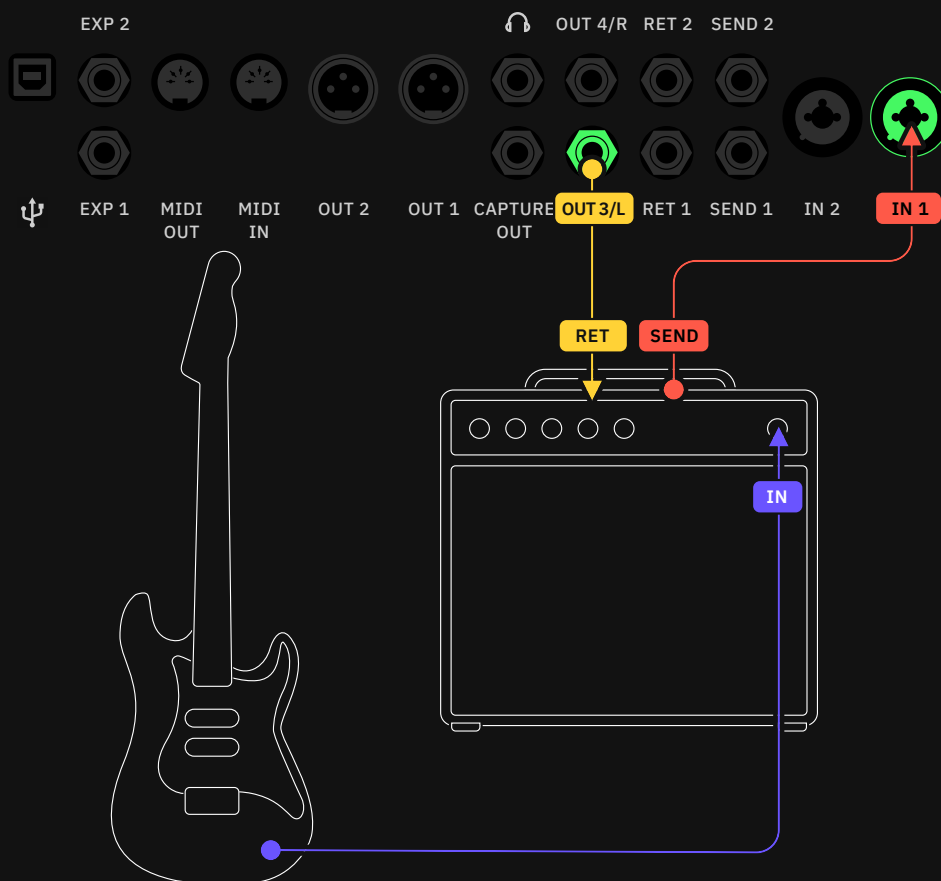

Preset Grid

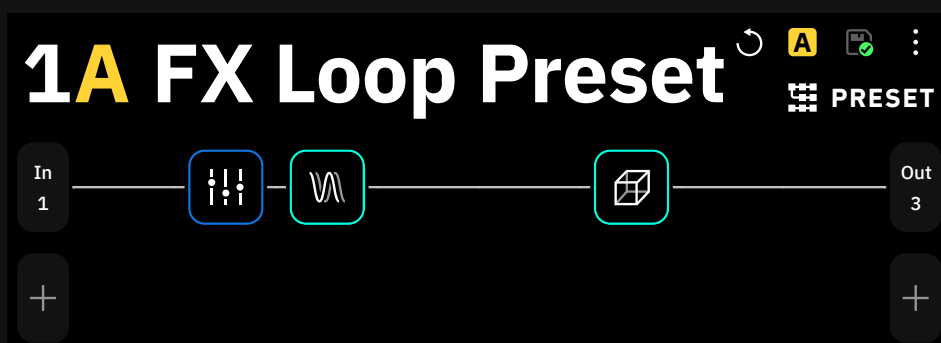

As FX Processor (pre only)

Similar to the previous method, you can use the Quad Cortex purely for pre effects, such as EQs, overdrives, noise gates, and pitch shift effects. Grid rows built for this purpose will contain only pre effects blocks.

1. Connect your instrument to **Input 1** on the Quad Cortex.
2. Place all the pre effects blocks you want on the first row of The Grid, and set the output to **OUT3/L**.
3. Connect the **OUT3/L** on the Quad Cortex to the input of your amplifier.

I/O Setup

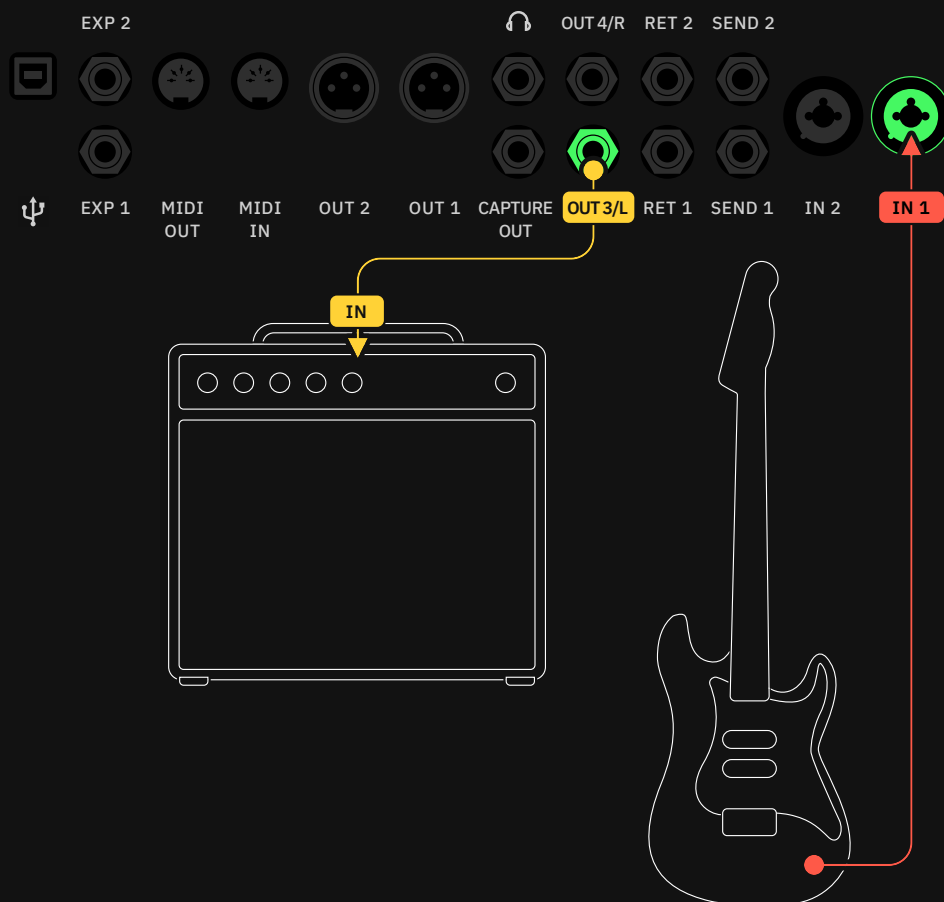

Preset Grid



Using external gear (FX loop)

The Effects Loop device block allows you to insert external effects into your signal chain on The Grid.

1. Connect your instrument to **Input 1**.
2. Build your signal chain on **The Grid**, then add an **FX Loop** device block (set to **FX Loop 1**) where you want to insert the external effects. Make sure the Mix parameter is set to 100%.
3. Connect a cable from **Send 1** on the Quad Cortex to the external effects.
4. From the output of the external effects, connect a cable to **Return 1** on the Quad Cortex.

I/O Setup

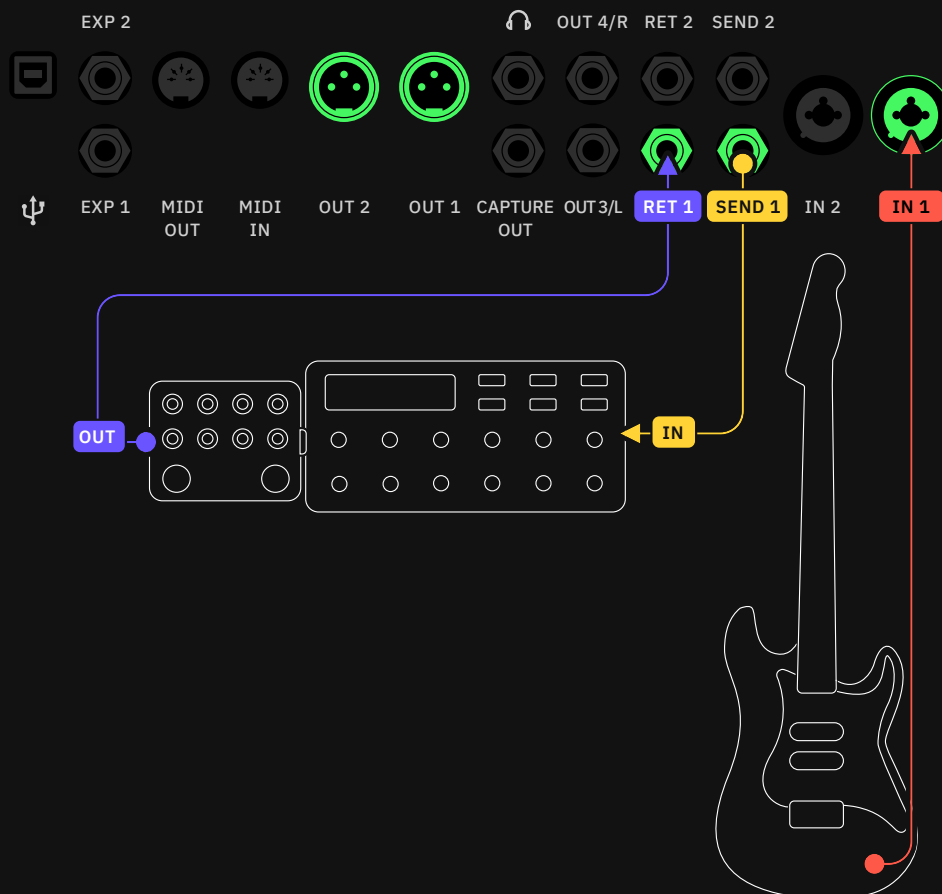

Preset Grid

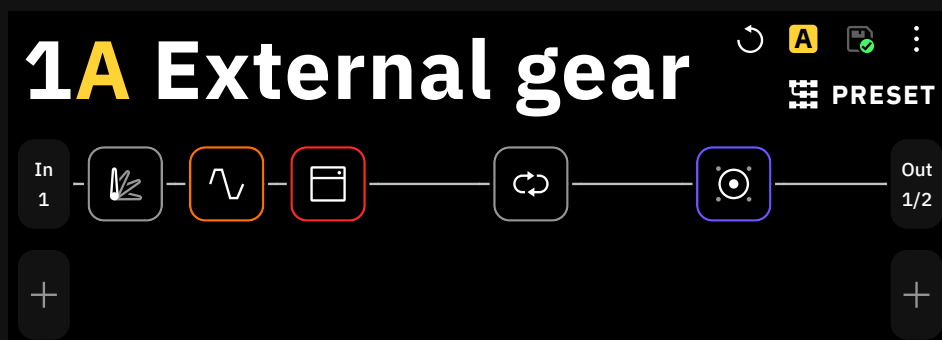

Stereo cab setup

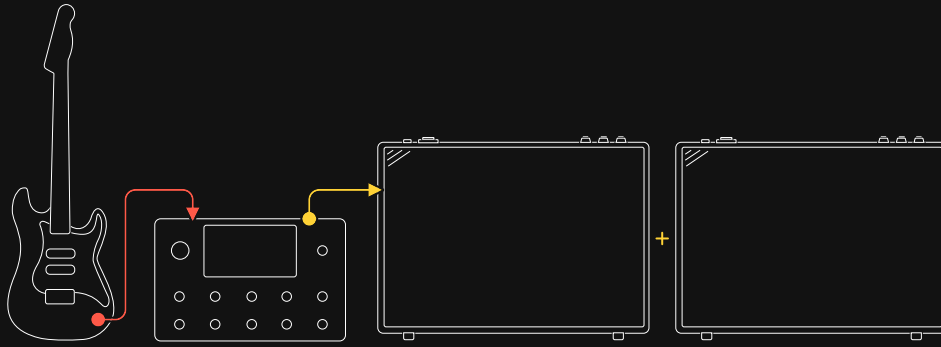

You can use two different cabinets and assign them separate outputs on Quad Cortex. Use the balance Splitter (0.50 value) to match the output volume on both cabs.

I/O Setup

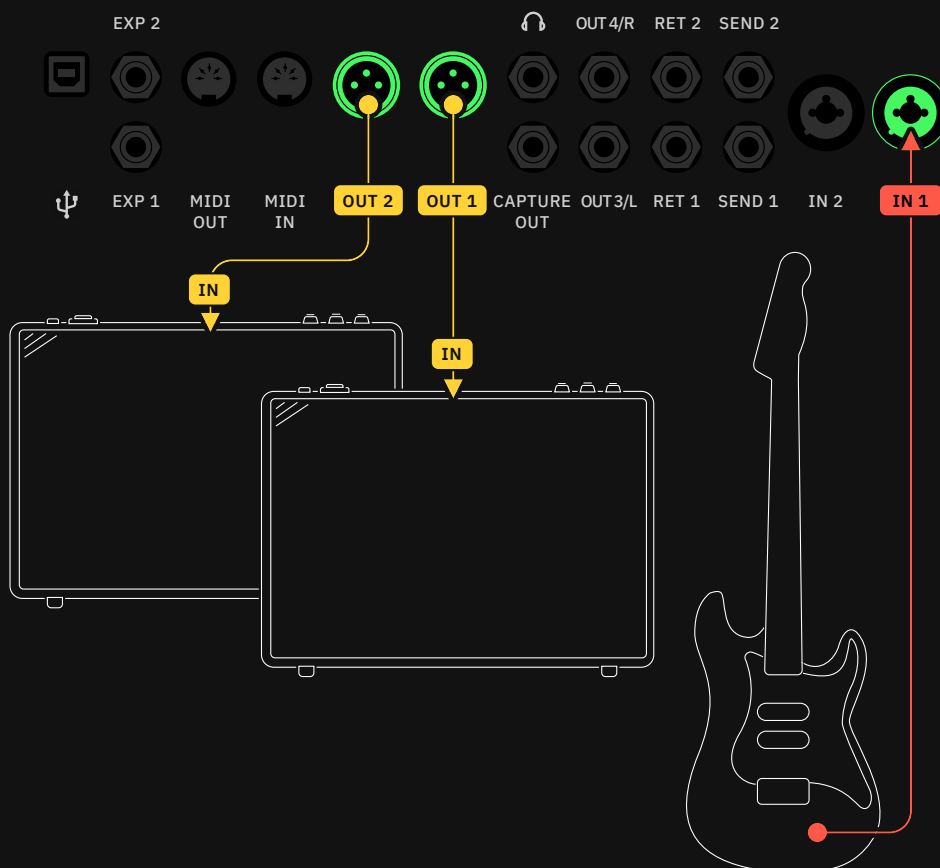

Preset Grid

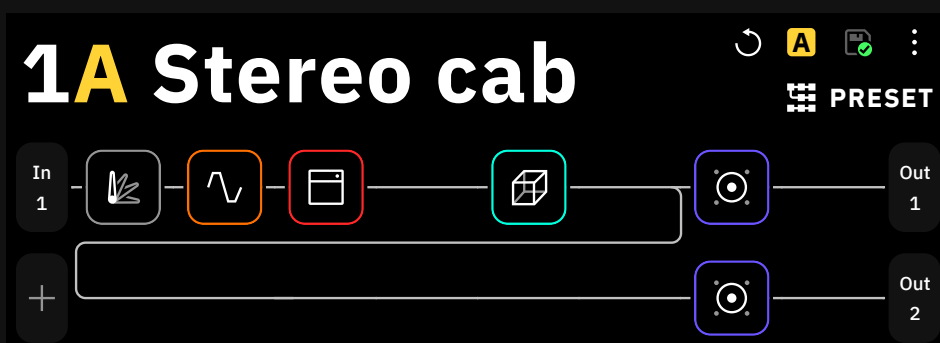

Guitar and vocals

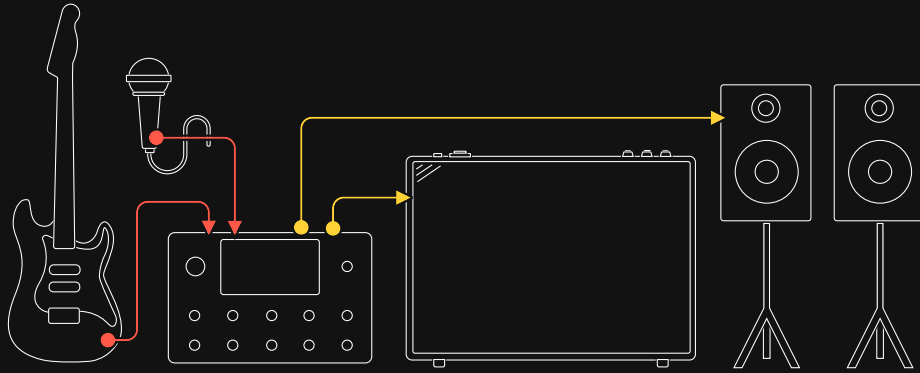

You can use Quad Cortex to process guitars and vocals separately. This example shows each row going through a mono output, however, you can assign stereo outputs for both rows.

I/O Setup

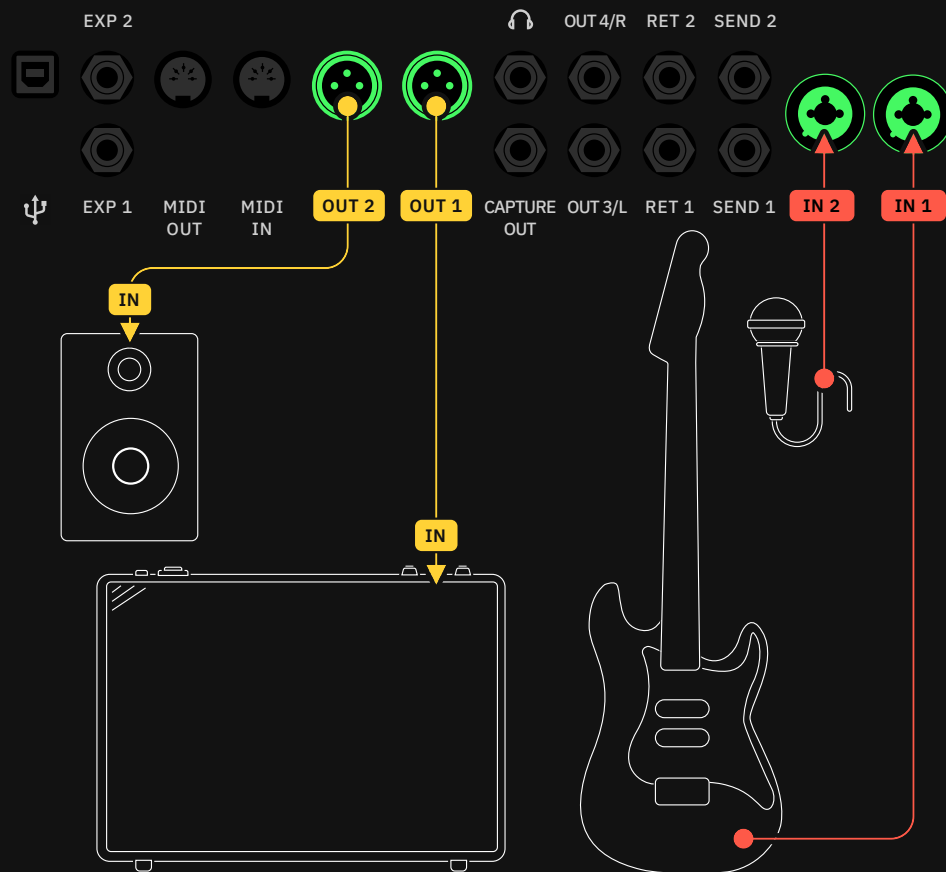

Preset Grid

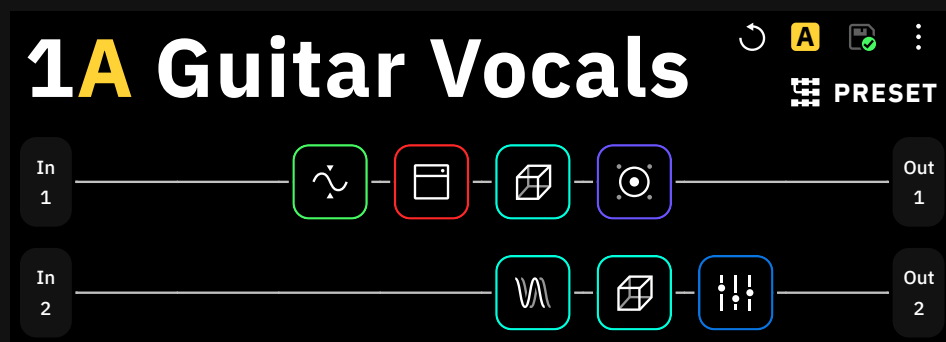

Two guitars and bass

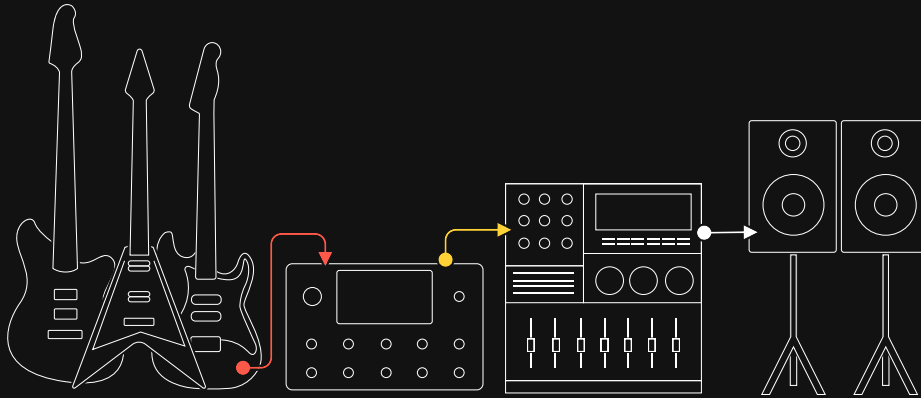

To process more than two instruments, you will need to use the Returns as instrument inputs.

I/O Setup

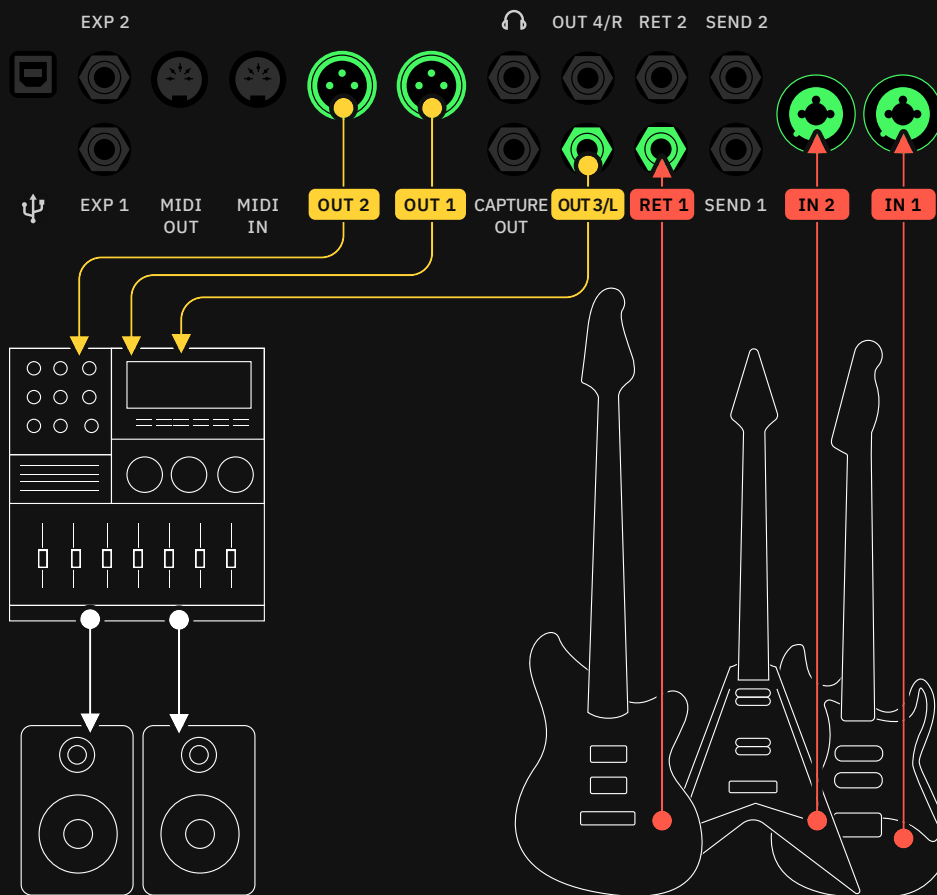

In this example, the bass is connected to the **Return 1** input. Each row uses a separate output.

Preset Grid

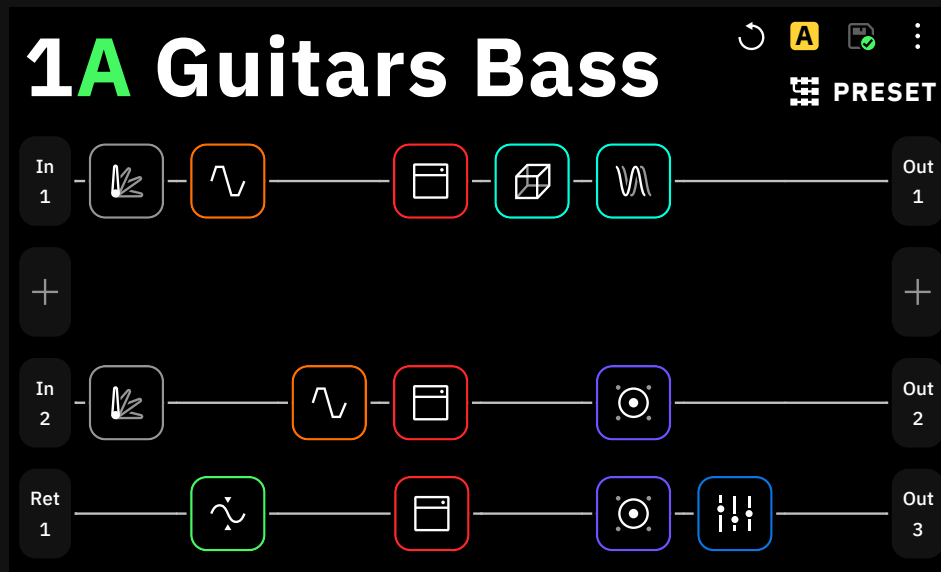

07

Neural Capture

Neural Capture is Quad Cortex's flagship feature. Built using our proprietary biomimetic AI, it can learn and replicate the sonic characteristics of any physical amplifier, cabinet, and overdrive pedal with unprecedented accuracy.

To create a Neural Capture you need to be able to mic up a cabinet or use an amplifier with a load box or D.I. Out.

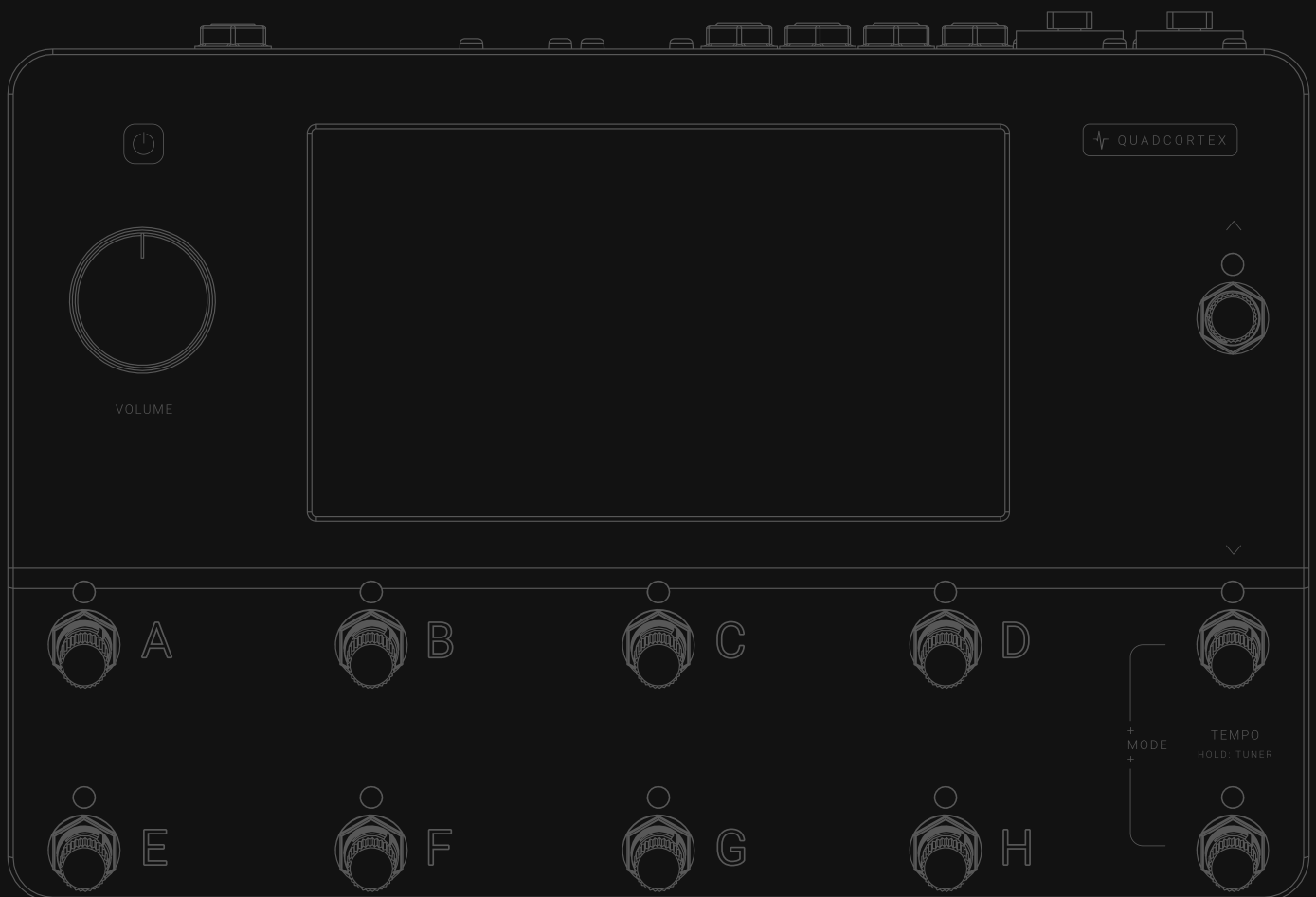

No special type of microphone is needed. Note that the Neural Capture is a global snapshot of a real device setup and that includes the microphone used and its placement as well.

Creating a new Neural Capture

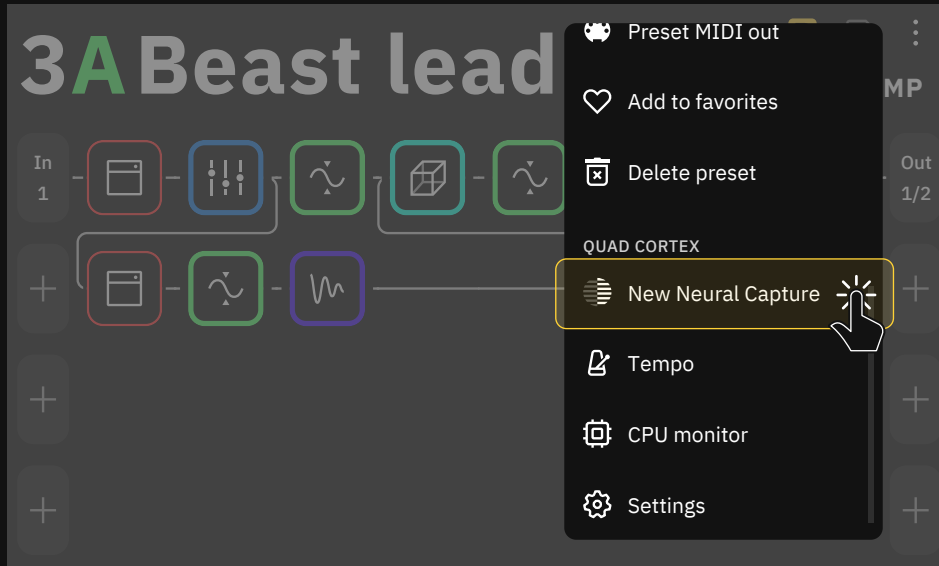

Start by tapping the Main Menu at the top-right corner of The Grid, then tap “**New Neural Capture**”

— Connection Diagram

WARNING:

Connecting the speaker output from a tube amplifier to the Quad Cortex could damage both units. Ensure you are using a D.I. Out and your amplifier is still connected to a cabinet or reactive load box.

1. Plug your instrument into **Return 1**.

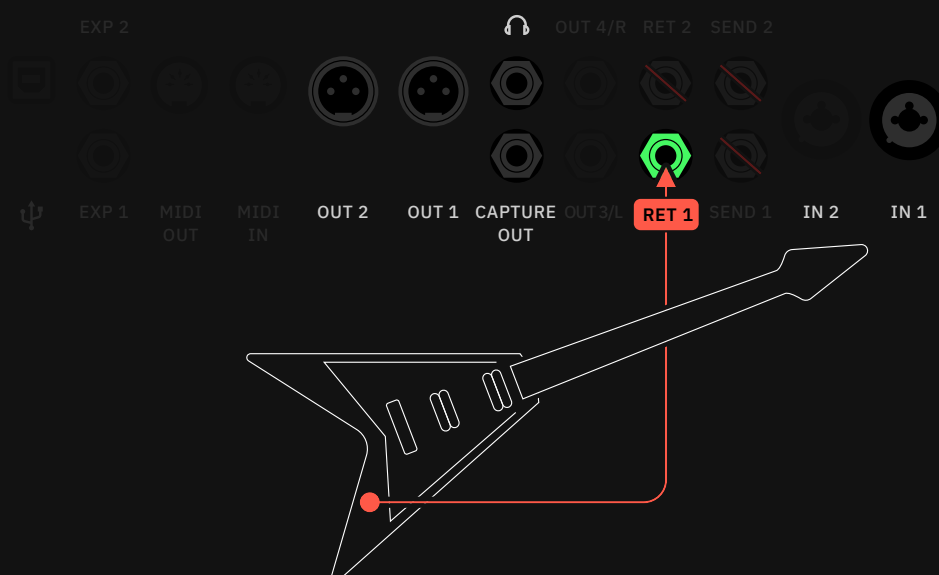

For the best results, **disconnect** any devices from **Send 1**, **Send 2**, and **Return 2**.

2. Connect your headphones and/or use your XLR outputs for monitoring.

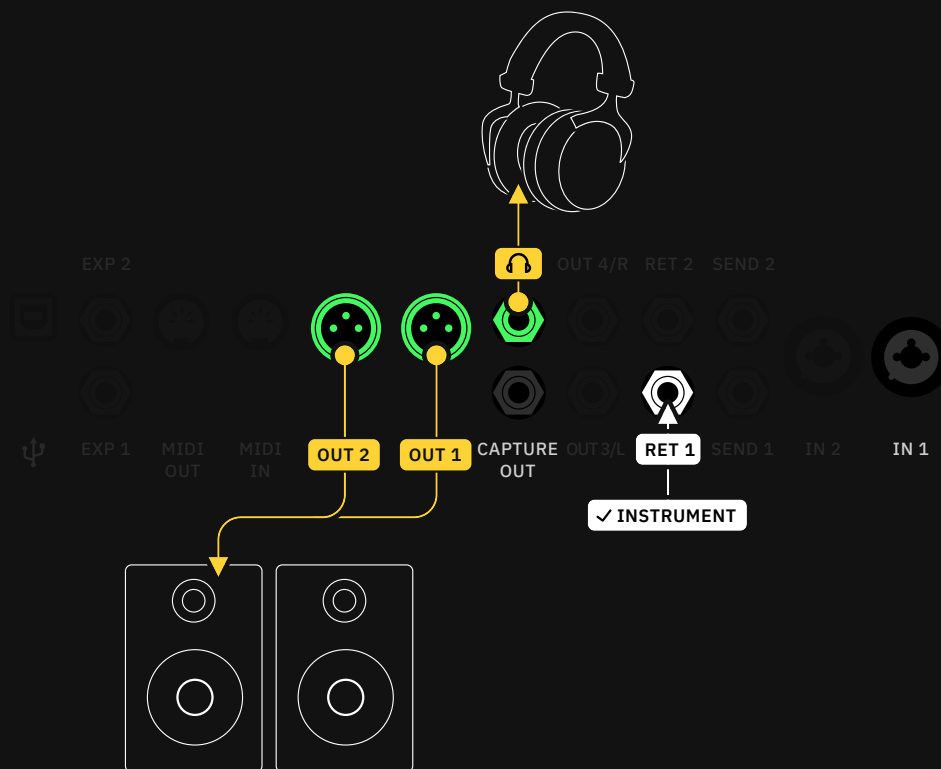

3. Connect **Capture Out** to the input of the **device being captured input**.

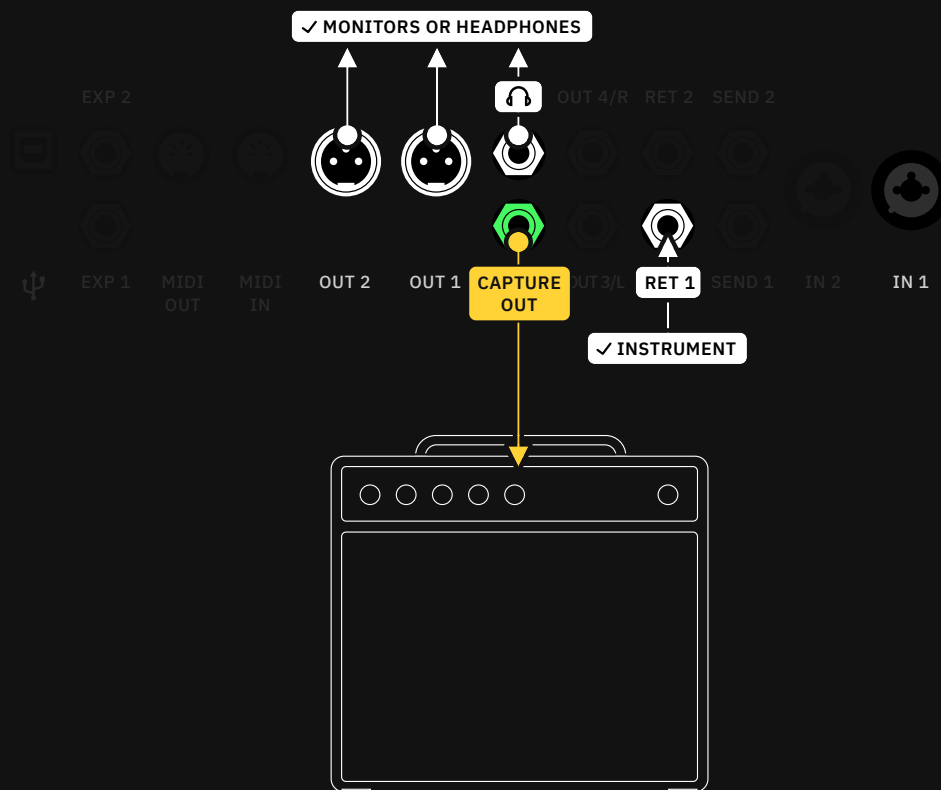

4. Position your microphone in front of the cabinet and connect it to INPUT 1.

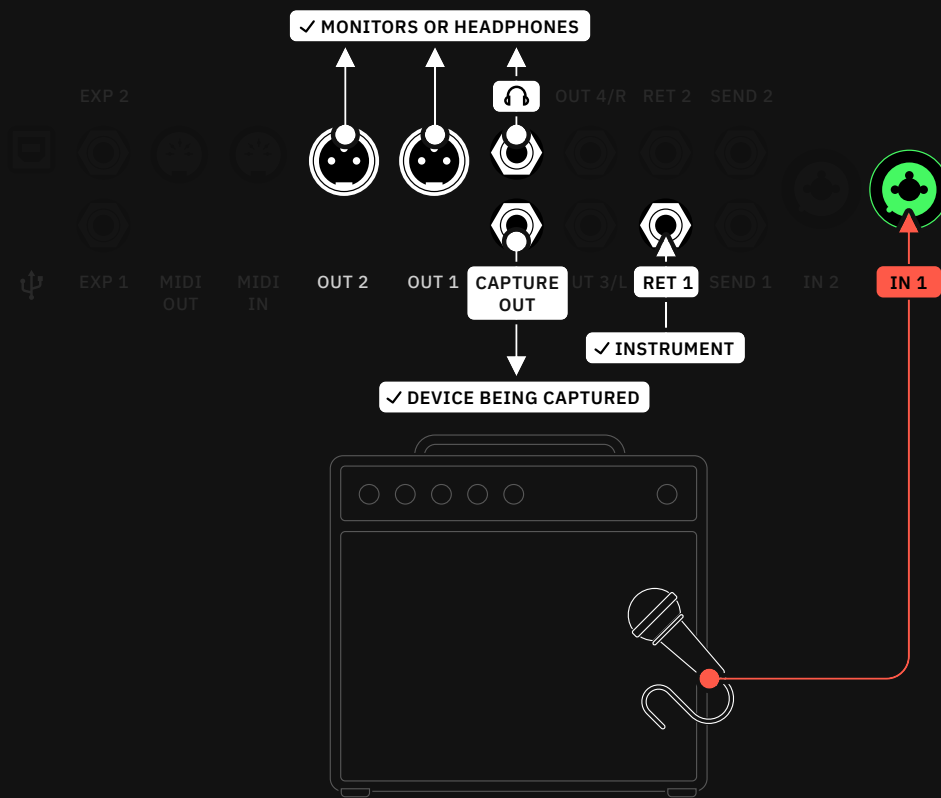

You can also Capture isolated overdrive/distortion pedals without using an amplifier. Connect them to Quad Cortex INPUT 1 using a TS cable.

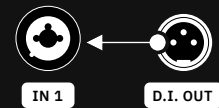

If you have an amplifier that has a D.I. Out, you can opt to use that instead of a microphone for capturing the amplifier without the cabinet.

5. Once everything is connected correctly, tap CONFIRM to start the Capture process.

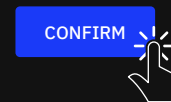

— Capture process

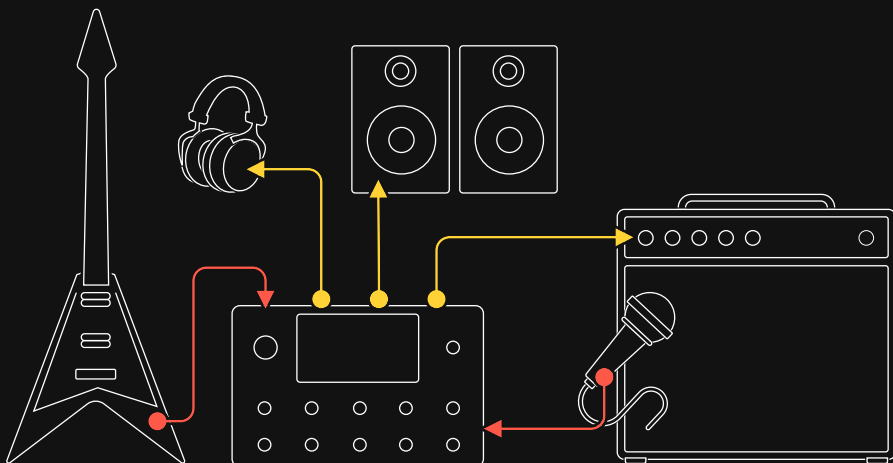

Set your microphone position and tweak the device parameters to your liking.

Here you can modify the levels in order to get a better performance during the Capture process.

Neural Capture

✕ Cancel

- Please verify your Quad Cortex is properly connected to the target device.
- Reduce levels if any of the meters detect clipping.
- The IN 1 GROUND LIFT can mitigate noise caused by ground loops between Quad Cortex and the target device.

CONNECTION DIAGRAM

START CAPTURE

INST LEVEL	IN 1 LEVEL	GROUND LIFT	TYPE	PHANTOM
0.71	0.00	On Off	Mic Instrument	On Off
0 dB	0 dB	LEVEL 0.71	AUTO-SET	

The **INST LEVEL** knob should be set as loud as possible without clipping (-10dB or higher if possible).

- **INST LEVEL KNOB:** Sets the input gain of the instrument signal
- **IN 1 LEVEL KNOB:** Sets the input gain of the microphone signal.
- **GROUND LIFT SWITCH:** Enable them in order to reduce or eliminate the ground-related noise arising from ground loops in audio cables or other sources.
- **TYPE SWITCH:** Toggles between “Mic” and “Instrument” inputs. Use “**Instrument**” if the device being captured is connected to Quad Cortex with a TS cable. Use “**Mic**” if the device being captured is connected to Quad Cortex with an XLR cable.
- **PHANTOM SWITCH:** Enables the Phantom Power (48v).

- **INST LEVEL METER:** Input signal meter.
- **IN 1 LEVEL METER:** Input signal meter.
- **HEADPHONE LEVEL KNOB:** Sets the output level of the headphones.
- **AUTO-SET BUTTON:** Sets the IN 1 level automatically. Play your instrument until the IN 1 knob stops moving.

Tap the **Start Capture** button to begin. The progress window will show the following steps:

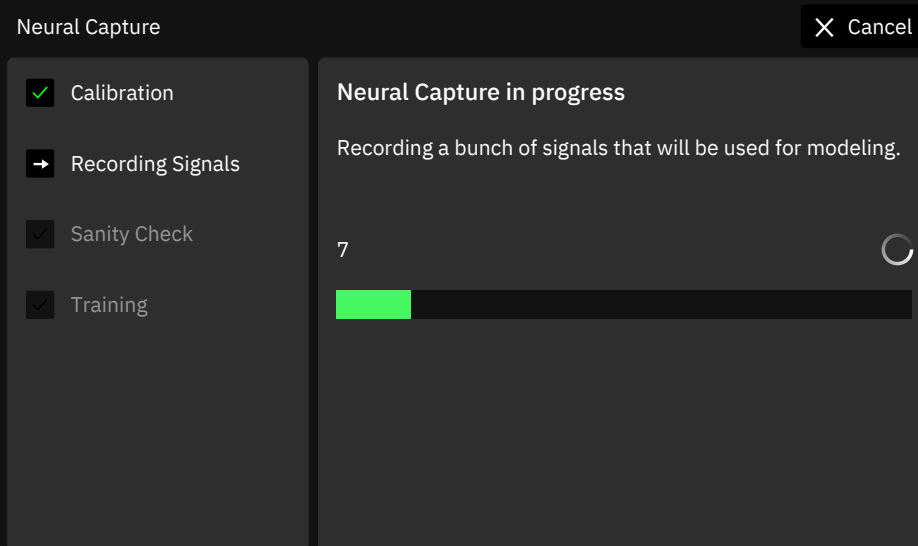

- **Calibration:** Measuring latency of the connected device. In the case of a digital device, keep latency as low as possible.
- **Recording Signals:** Recording signals that will be used for modeling.
- **Sanity Check & Training:** The core of Neural Capture. Training a neural network to emulate the sound of your device. If the Sanity Check fails, use the AUTO-SET feature to get optimal input levels.

— Testing a Neural Capture

After the Capture process, your Neural Capture will be ready for testing.

Neural Capture

✕ Cancel

Your Neural Capture is ready. Switch between the reference and Quad Cortex using the buttons below.

START FROM SCRATCH

SAVE

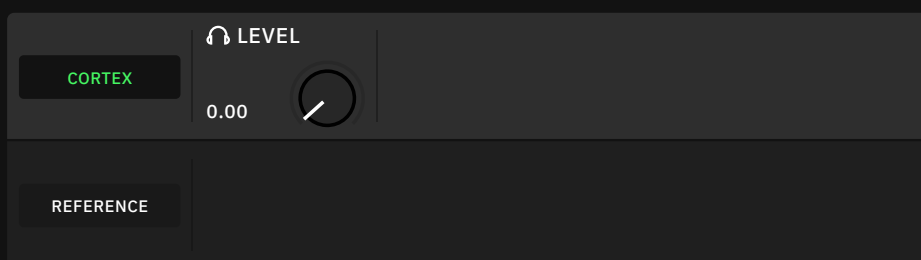

- **CORTEX & REFERENCE BUTTONS:** Tap them to toggle between the original device signal and the Neural Capture. Footswitch A can be pressed or turned to switch between the two.
- **HEADPHONES KNOB:** Sets the output level of Quad Cortex in the mix (*Rotary footswitch B assigned automatically*).
- **START FROM SCRATCH BUTTON:** Start the Neural Capture process again.

— Saving a Neural Capture

Tap the SAVE button to save your Neural Capture.

NEURAL CAPTURE NAME

LX65 57 Axis

TAGS

57, rhythm, combo



In the save menu, you can name your Neural Capture as well as assign it tags.

If you want to know how to share a Neural Capture, please check the [Cortex Cloud](#) section.

Using a Neural Capture

Captures can be used by loading a **Neural Capture** block on The Grid. Tap an empty space on The Grid and select “**Neural Capture**” in the Device Category list.

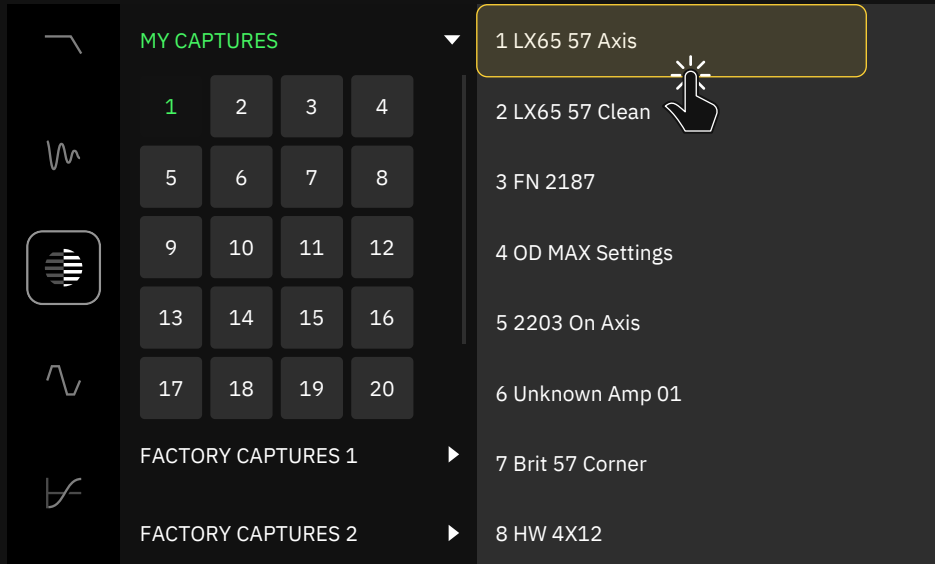

This will open the Virtual Device Library, where you can navigate through the different Neural Capture folders, “**My Captures**”, “**Factory Captures 1**”, and “**Factory Captures 2**”. Each folder has 32 banks of 8 Capture slots. Tap a Neural Capture in a bank to add it to The Grid.

After selecting a Neural Capture, it will be placed as a device block on The Grid. Tap on it to access its parameters.

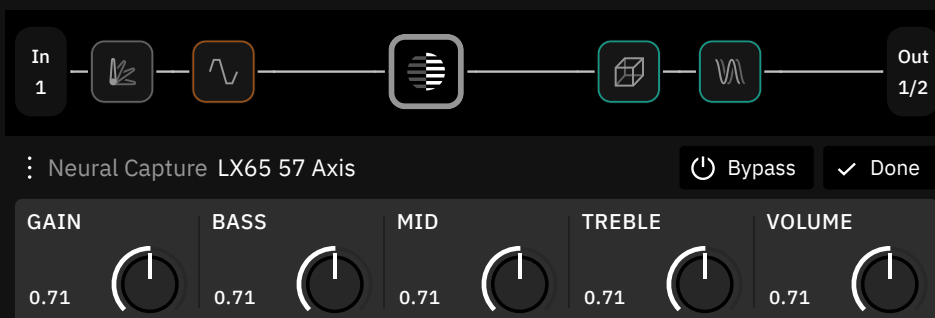

- **GAIN** [dB]: Determines the gain in the preamp section of the model.
- **BASS** [dB]: Affects the low-end of the signal.
- **MID** [dB]: Affects the mid-range of the signal.
- **TREBLE** [dB]: Affects the high-end of the signal.
- **VOLUME** [dB]: Determines the output level of the model.

08

Computer Integration

Quad Cortex can function as an audio interface by connecting it to your computer via USB.

For USB audio operation on Windows® computers, it is necessary to download and install the **Quad Cortex ASIO® driver** from our website. There is no driver installation necessary for Mac® computers.

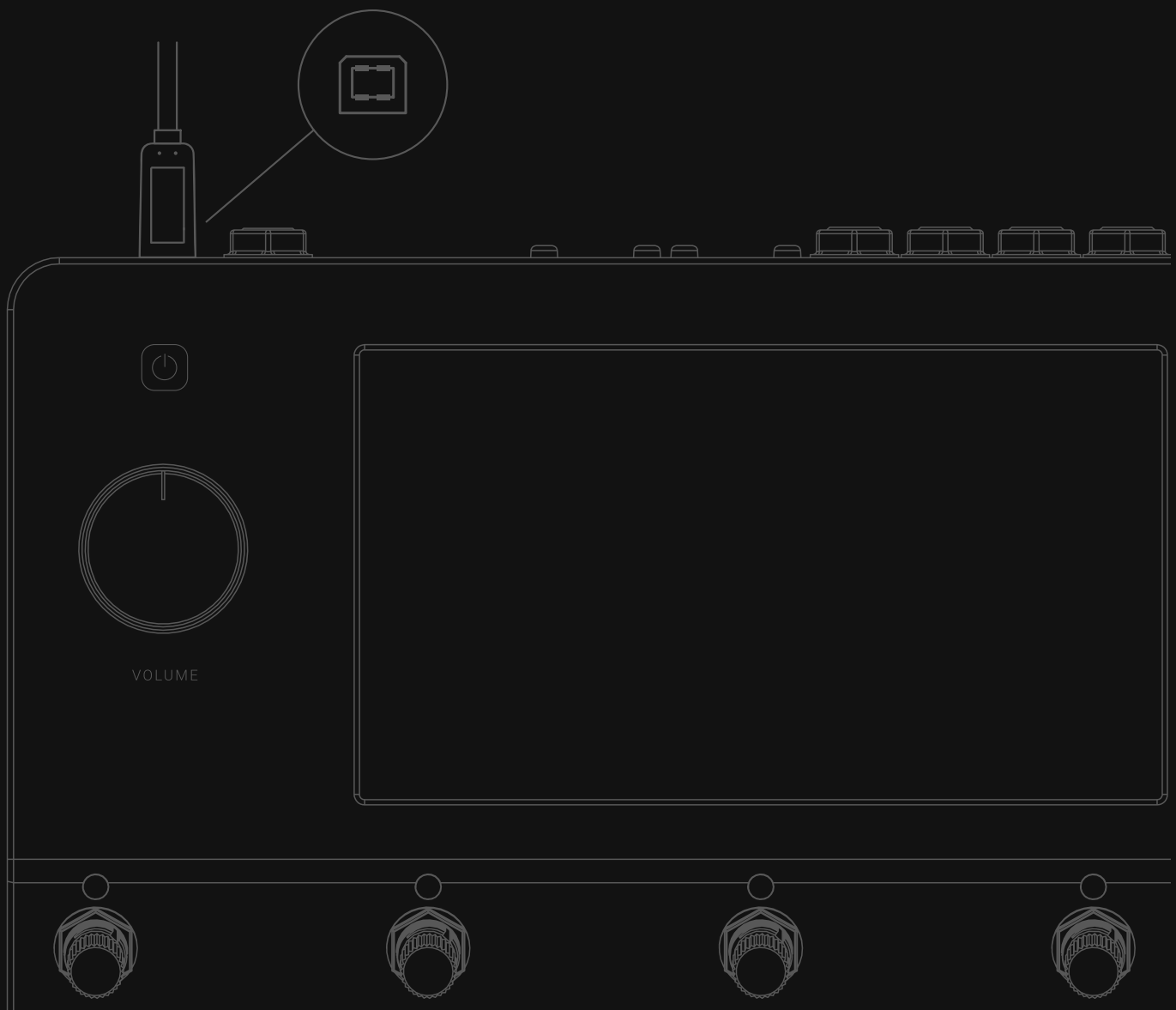

USB Audio

Quad Cortex functions as a USB 2.0, 24-bit, 48kHz (fixed), low-latency audio interface for Windows® and Mac® computers. It features 8 inputs & 8 outputs compatible with all major DAWs.

Use the USB Type-B cable included in the box to connect your Quad Cortex to your computer.

— macOS® setup

- After connecting Quad Cortex to your Mac®, you are able to use it as a device for sound input and output.
- Go to “System Preferences”, “Sound”, and set Quad Cortex to be the **Output** and **Input** device.
- Use Quad Cortex’s VOLUME wheel to set your output volume.

— Windows® setup

- Download the driver installer from our website.
- Run the installer. When it completes, reboot both your computer and Quad Cortex.
- Go to Control Panel > Hardware and Sound > Sound, and make sure your Quad Cortex is set as the default device in both Playback and Recording tabs.
- Right-click the Quad Cortex, select Properties > Advanced options, and ensure that the Sample Rate is set to 48000 Hz. Repeat this process for both Playback and Recording tabs.

The Quad Cortex driver will be installed in the following path location by default:

C:\Program Files\NeuralDSP\USB Audio Device Driver

Hardware & DAW Monitoring

If Quad Cortex is selected as the main audio device on your computer, you will hear the computer audio through Quad Cortex **Outputs 1/2** and **Headphone Output**. This feature lets you jam along with YouTube™, Spotify®, iTunes®, or your DAW tracks with low latency monitoring.

Recording Quad Cortex’s processed signal, dry input, or specific rows is also possible. In either case, you will hear your signal from Quad Cortex before it’s routed through the DAW, which is great for low latency monitoring.

You can use multiple inputs and outputs by tapping the **Input** and **Output blocks** on both sides of The Grid. **USB Inputs** and **USB Outputs** are also available here. This feature allows getting different routings without connecting any additional cables to the unit.

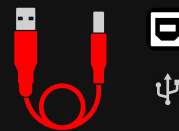

USB devices may stop functioning correctly or turn completely unresponsive when they are attached to the same USB hub.

Avoid connecting Quad Cortex to **USB hubs** or **front panel USB ports** of PC cases. Use **motherboard ports** (USB 2.0 or higher) instead.

For advanced settings, open the **Audio MIDI Setup** app from the Applications folder.



[Download](#) the Quad Cortex driver installer for Windows®.

Monitoring with both Quad Cortex and a DAW at the same time could cause phase issues. In order to avoid any issues, **turn off** input monitoring on the audio track.



I/O Schematic

Quad Cortex features **16 USB channels** (8in/8out). Each channel is mapped to a specific source or Quad Cortex's audio connector.

HOST USB CHANNEL	DESCRIPTION	QUAD CORTEX USB CHANNEL
Input 1	DI signal from analog Inputs 1/2 to host (non-selectable on The Grid). Select Inputs 1/2 on your host to record DI tracks.	Output 1
Input 2		Output 2
 Dry/Wet swap via I/O Settings 		
Input 3	Manual route from The Grid selectable output blocks to the host. Select Inputs 3/4 on your host to route signal from the The Grid output.	Output 3
Input 4		Output 4
Input 5	Manual route from The Grid selectable output blocks to the host. Select Inputs 5/6 on your host to route signal from The Grid output.	USB Output 5
Input 6		USB Output 6
Input 7	Manual route from The Grid selectable output blocks to the host. Select Inputs 7/8 on your host to route signal from The Grid output.	USB Output 7
Input 8		USB Output 8
Output 1	Playback from the host through XLR Outputs (non-selectable on The Grid) Select Outputs 1/2 on your host to hear playback through Quad Cortex's Outputs 1/2 or Headphones Out .	Input 1
Output 2		Input 2
Output 3	Playback from the host through TRS Outputs (non-selectable on The Grid). Select Outputs 3/4 on your host to hear the signal through Quad Cortex's Outputs 3/4 .	Input 3
Output 4		Input 4
Output 5	Manual route from the host to Quad Cortex's input blocks. Select Outputs 5/6 on your host to route the signal to a row in The Grid.	USB Input 5
Output 6		USB Input 6
Output 7	Manual route from the host to Quad Cortex's input blocks. Select Outputs 7/8 on your host to route the signal to a row in The Grid.	USB Input 7
Output 8		USB Input 8

DRY - WET

 3/4 - 1/2
 1/2 - 3/4

Use the **Dry/Wet switch** in the I/O Settings menu to swap between clean DIs or processed signal fed into USB Outputs 1-2 or 3-4.

— Recording a Dry D.I. Track

A common DAW recording technique is to record a dry D.I. (Direct Input) signal from your instrument or microphone along with your processed tone. Only a single-row Preset is needed for recording both processed and dry signals from Quad Cortex.

Routing:

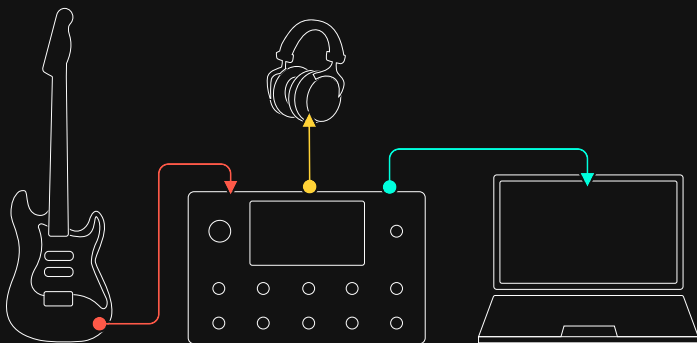

Preset Grid



The instrument is connected to Quad Cortex’s **INPUT 1** and it’s being monitored by headphones only. Quad Cortex is connected to the laptop through USB.

- Open your DAW and choose Quad Cortex as main audio device.
- Create a **mono audio track** and set its input as **Input 1**. The track will receive the dry input signal coming from your instrument.
- Then, create a **stereo audio track** and set its input as **Input 3/4**. The track will receive the processed signal coming from the row via **USB 3/4**.
- Finally, arm both tracks for recording.

The Multi-Out block routes your signal through XLR Outs 1/2 as well as TRS Outs 3/4, and USB. It’s the default setting for all Factory Presets and newly created Presets.

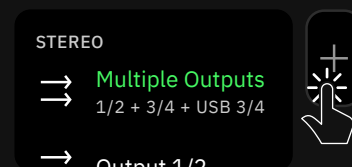

Tap any output block in The Grid then select “**Multiple Outputs**” to enable this feature.

— D.I. Recording and Re-Amplification

Quad Cortex allows processing the D.I. track later with, for example, **Neural DSP plug-ins** and/or re-amplify the D.I. track through an amp or back through the Quad Cortex unit again.

Routing:

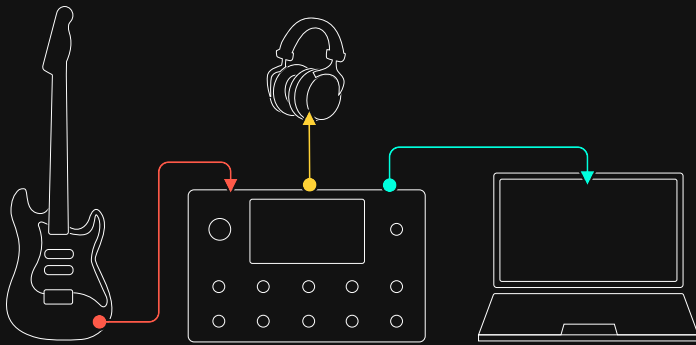

Preset Grid #1



The instrument is connected to Quad Cortex’s **INPUT 1** and it’s being monitored by headphones only. Quad Cortex is connected to the laptop through USB.

- Open your DAW and choose Quad Cortex as the main audio device.
- Create a **mono audio track** and set its input as **Input 1**. The track will receive the dry input signal coming from your instrument.
- Then, create a **stereo audio track** and set its input as **Input 3/4**. The track will receive the processed signal coming from the row via **USB 3/4**.
- Finally, arm both tracks for recording.

The Multi-Out block routes your signal through XLR Outs 1/2 as well as TRS Outs 3/4, and USB. It’s the default setting for all Factory Presets and newly created Presets.

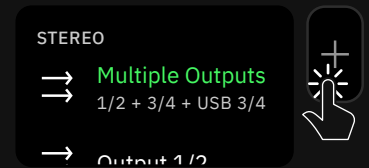

Tap any output block in The Grid then select “**Multiple Outputs**” to enable this feature.

Preset Grid #2



Check the following steps to send back the recorded DI to Quad Cortex:

- Select the dry audio track output as **Output 5**.
- Choose **USB 5** as an input block in The Grid.
- Press **PLAY** in your DAW.

Quad Cortex will receive the signal coming from the track. All the device blocks placed in the row will affect the signal.

Recording the re-amped signal in your DAW is also possible.

- Add another audio track and set its inputs as **Inputs 3/4**.
- Arm the track for recording.

Connecting Quad Cortex to an iPhone® or iPad®

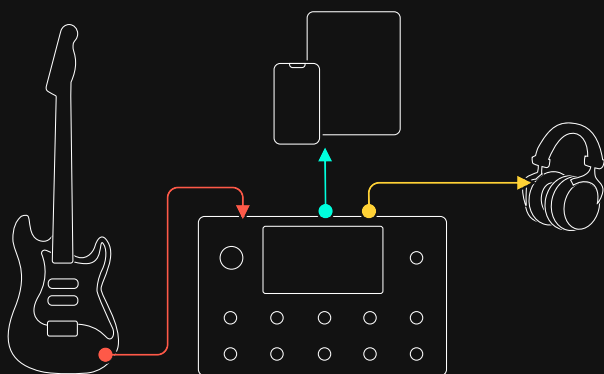

You can connect any class-compliant USB audio device or MIDI controller to an iPhone® or iPad®. As those peripherals, Quad Cortex can be used as an audio interface using the **Apple® Lightning to USB-3 Camera Adapter**.

This feature allows using Quad Cortex with audio apps like GarageBand® for recording purposes, or simply using Quad Cortex as the main audio device for different apps.

The Multi-Out block routes your signal through XLR Outs 1/2 as well as TRS Outs 3/4, and USB. It's the default setting for all Factory Presets and newly created Presets.

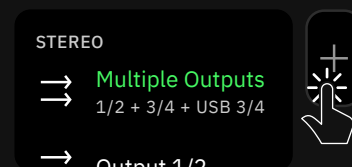

Tap any output block in The Grid then select “**Multiple Outputs**” to enable this feature.

09

MIDI

Quad Cortex is capable of sending and receiving MIDI messages over USB in the same way as via its MIDI Din connectors.

IMPORTANT: For USB MIDI operation on Windows® computers, it is necessary to download and install the Quad Cortex ASIO® driver, available from our website. There is no driver installation necessary if you're using an Apple Mac computer.

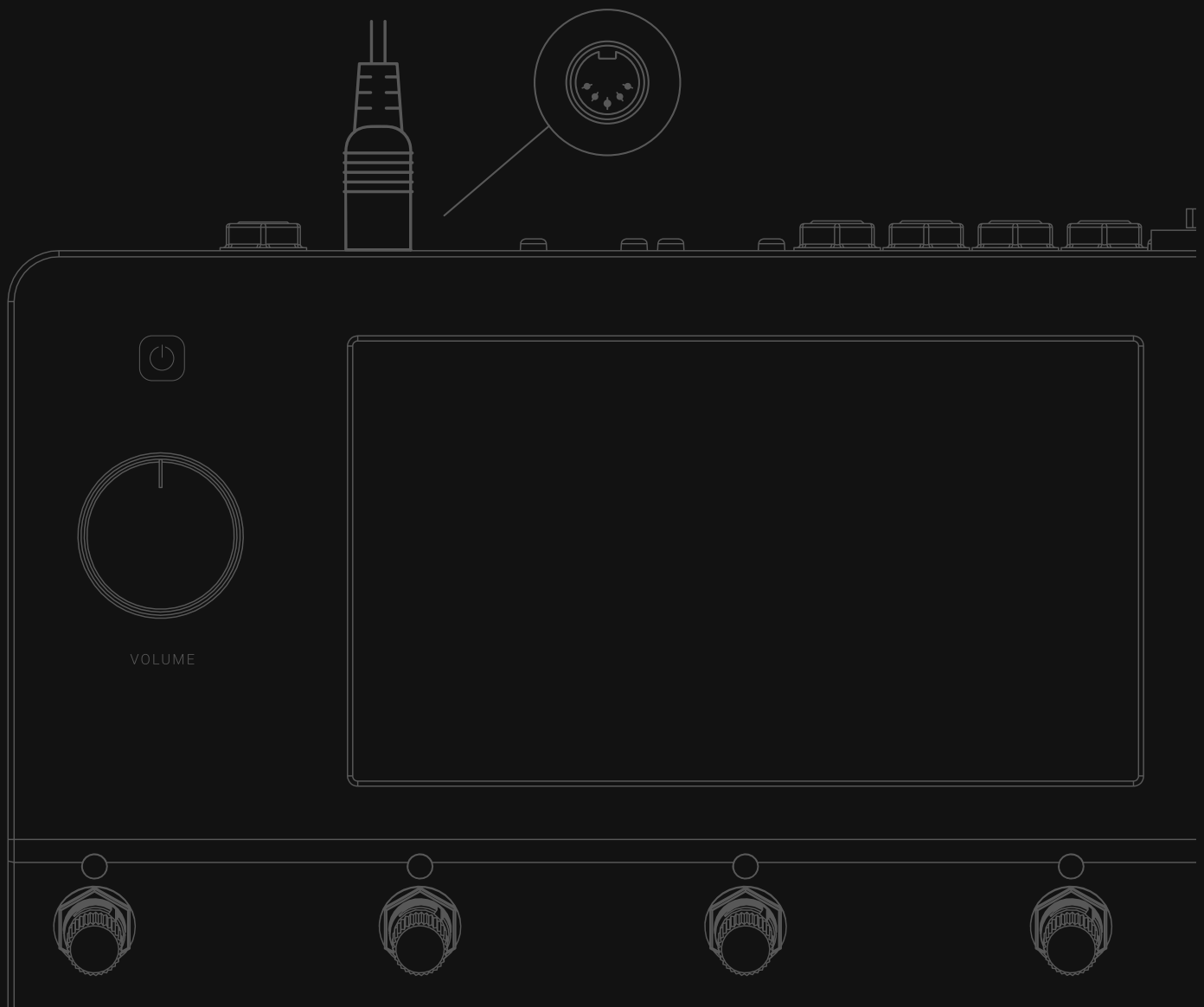

MIDI Settings Menu

Tap the Main Menu on The Grid and select **Settings** to access to the **MIDI Settings** screen.

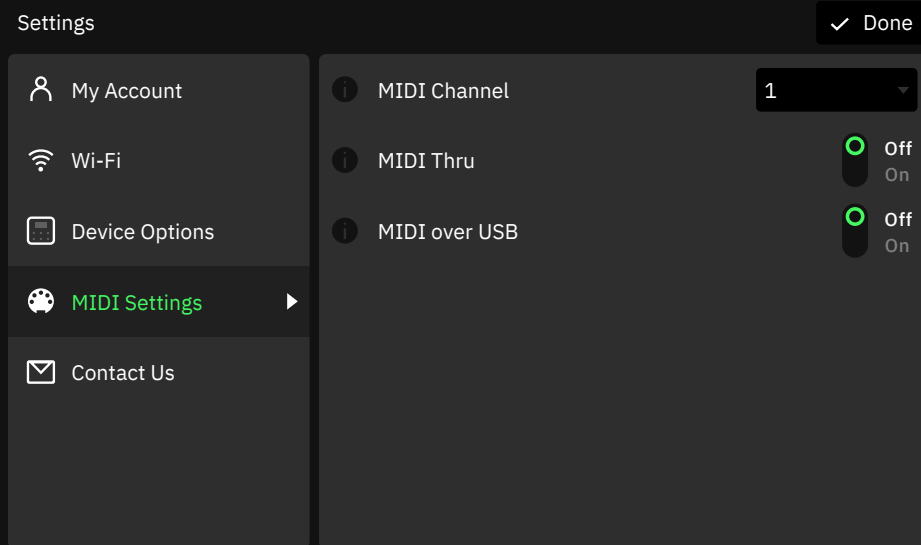

- **MIDI CHANNEL LIST:** Sets the Quad Cortex base MIDI channel. The default value is 1.
- **MIDI THRU SWITCH:** Sets MIDI Thru ON or OFF. MIDI Thru allows many devices to have their MIDI connections daisy-chained together to be driven by a common MIDI source. This setting is available in the **I/O Settings** as well. The default value is OFF.
- **MIDI OVER USB SWITCH:** Enables or disables MIDI over USB. The default value is ON.

Preset MIDI Out Settings

Quad Cortex is capable of sending MIDI messages to external devices. Those messages can be mapped and modified in the **Preset MIDI Out** settings menu.

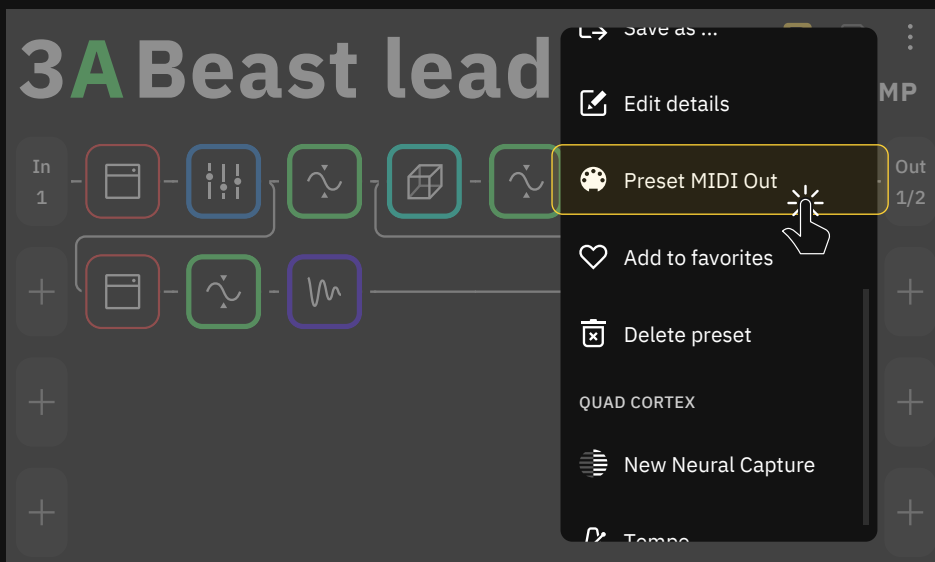

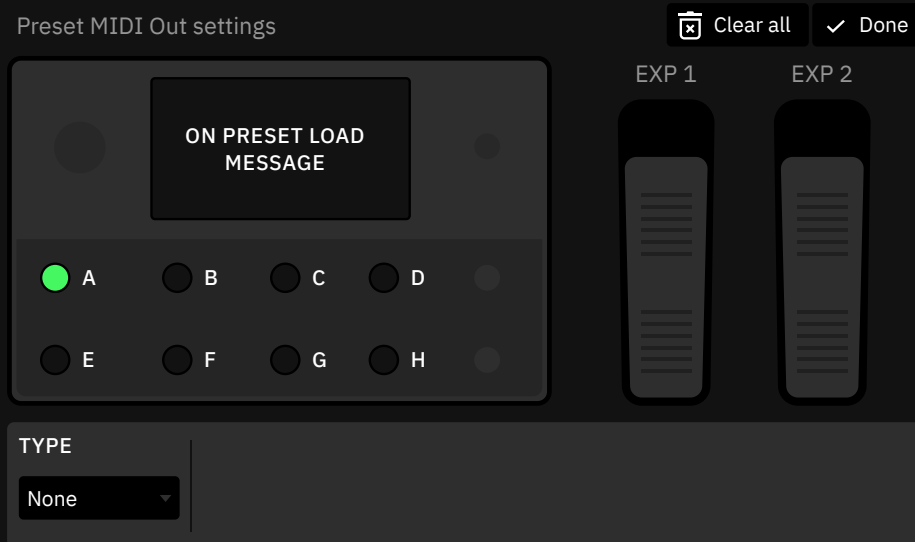

- **ON PRESET LOAD MESSAGE:** Set up to 12 MIDI commands that will be sent once you load the current Preset.
- **A-H FOOTSWITCHES:** Tapping them will allow you to modify the type (CC/CC Toggle/PC), channel, command number, and value (0 - 127) of the message assigned to each footswitch.
- **EXP PEDAL 1-2:** Can switch between unassigned (none) and CC in the type field. Once it's assigned, you can modify the channel, command number, min value, and max value.
- **TYPE:** When available, you can select the type of message that will be sent (CC/CC Toggle/PC). For expression pedals, only CC messages are available.

CC TYPE

- **CHANNEL:** Choose from 1 to 16 to select the channel that will send the MIDI commands.
- **CC#:** Choose from 0 to 127 to select the CC number.
- **VALUE:** Choose from 0 to 127 to select the value that will be sent.

CC TOGGLE TYPE

- **CHANNEL:** Choose from 1 to 16 to select the channel that will send the MIDI commands.
- **CC#:** Choose from 0 to 127 to select the CC number.
- **MIN VALUE:** 0 - 127. Determines the value sent when the footswitch LED is dim.
- **MAX VALUE:** 0 - 127. Determines the value sent when the footswitch LED is bright.

PC TYPE

- **CHANNEL:** Choose from 1 to 16 to select the channel that will send the MIDI commands.
- **BANK CC#0: 0 - 127.** Determines the MSB.
- **BANK CC#32: 0 - 127.** Determines the LSB.
- **PROGRAM#:** Choose from 0 to 127 to select the PC number.

Tap Done to close the Preset MIDI Out Settings window.

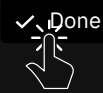

4A MIDI

↺ A 📄 ⋮
🎮 SCENE

In 1

👉

🗑️

📄

🎯

📦

Out 1/2

4A MIDI

↺ A 📄 ⋮
🎮 STOMP

In 1

👉

🗑️

📄

🎯

📦

Out 1/2

Note the footswitch and expression pedal MIDI commands can only be sent in **SCENE** or **STOMP** Modes. **The outgoing MIDI commands will be deactivated in PRESET Mode.** However, any outgoing “ON PRESET LOAD” MIDI messages will be sent in PRESET mode.

Incoming MIDI

Quad Cortex can receive CC and PC messages via MIDI DIN or USB. You can use external devices to change Presets and for other features.

Receiving MIDI Program Change messages (PC)

Incoming MIDI Program Change messages change Presets and Setlists on Quad Cortex.

- We use CC#32 for changing Setlists, supporting up to 128 Setlists (value 0-127).
- CC#0 is used for splitting up the Setlists in to groups of 128 Presets. CC#0 value 0 is used for Presets 0-127 and CC#0 value 1 is used for Presets 128-256.

Example #1

If you want to load the **Quad Cortex Preset 129 (17A)** in **Setlist 5**, then you would send the following **PC message** to the unit:

- CC#0 value 1, CC#32 value 5, Program #1

Example #2

If you want to load the **Quad Cortex Preset 68 (9D)** in **Setlist 9**, then you would send the following **PC message** to the unit:

- CC#0 value 0, CC#32 value 9, Program #67

Important: The last CC#0 value # is remembered until you change the CC#0 value again and choose to load a Preset from a different Preset group.

Receiving MIDI Continuous Controller messages (CC)

CC messages can be used for the following purposes:

- Change Mode.
- Change Scene.
- Tap Tempo BPM.
- Enable/bypass footswitches A-H.
- Open/Close Gig View.
- Open/Close the Tuner.

Incoming MIDI Reserved CC List

Quad Cortex has reserved specific MIDI CC messages for global functions.

CC# 0 Value 0: Preset group 0-127 CC# 0 Value 1: Preset group 128-256	Bank (MSB)
CC# 1 Value 0-127	Expression pedal 1
CC# 2 Value 0-127	Expression pedal 2
CC# 32 Value 0-127	Bank (LSB) - Setlist change (Program Change)
CC# 35 Value 0-127	Enable/bypass Footswitch A (Preset/Stomp/Scene Mode, and Gig View)
CC# 36 Value 0-127	Enable/bypass Footswitch B (Preset/Stomp/Scene Mode, and Gig View)
CC# 37 Value 0-127	Enable/bypass Footswitch C (Preset/Stomp/Scene Mode, and Gig View)
CC# 38 Value 0-127	Enable/bypass Footswitch D (Preset/Stomp/Scene Mode, and Gig View)
CC# 39 Value 0-127	Enable/bypass Footswitch E (Preset/Stomp/Scene Mode, and Gig View)
CC# 40 Value 0-127	Enable/bypass Footswitch F (Preset/Stomp/Scene Mode, and Gig View)
CC# 41 Value 0-127	Enable/bypass Footswitch G (Preset/Stomp/Scene Mode, and Gig View)
CC# 42 Value 0-127	Enable/bypass Footswitch H (Preset/Stomp/Scene Mode, and Gig View)
CC# 43 Value 0-7	Scene select (A-H)
CC# 44 Value 0-127	Tempo BPM
CC# 45 Value 0-127	Tuner On/Off
CC# 46 Value 0-127	Open/Close Gig View
CC# 47 Value 0-2	Change modes (Stomp/Preset/Scene) <ul style="list-style-type: none"> • CC#47 value 0 loads Preset Mode • CC#47 value 1 loads Scene Mode • CC#47 value 2 loads Stomp Mode

Looper X MIDI Reserved CC List

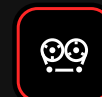

The Looper X has reserved specific MIDI CC messages for its functions.

CC #48 Value 64-127	Open / Close Looper UI (<i>Always opens in perform mode</i>)
CC #49 Value 64-127	Duplicate/Stop Duplicate
CC #50 Value 64-127	Enable/disable One Shot
CC #51 Value 64-127	Enable/Disable Half Speed
CC #52 Value 0-127	<p>Punch Feature.</p> <ul style="list-style-type: none"> Value 0-63 = Punch Out Value 64-127 = Punch In/Punch Out <p><i>*Value 0-63 works as long as the parameter is set to momentary and value 0-63 is sent on MIDI controller footswitch release.</i></p>
CC #53	<p>Record/Stop.</p> <ul style="list-style-type: none"> Value 0-63 = Stop recording Value 64-127 = Record/Overdub/Stop <p><i>*Value 0-63 works as long as the parameter is set to momentary and value 0-63 is sent on MIDI controller footswitch release.</i></p>
CC #54 Value 64-127	Play/Stop
CC #55 Value 64-127	Enable/Disable Reverse
CC #56 Value 64-127	Undo/Redo
CC #57 Value 0-1	<p>Duplicate Mode parameter</p> <ul style="list-style-type: none"> Value 0 = Free Value 1 = Sync
CC #58 Value 0-9	<p>Quantize parameter</p> <ul style="list-style-type: none"> Value 0 = OFF Value 1-8 = 1-8 Beats Value 9 = 16 Beats
CC #59 Value 0-1	<p>MIDI Clock Start</p> <ul style="list-style-type: none"> Value 0 = OFF Value 1 = ON
CC #60 Value 0-1	<p>Perform / Params mode</p> <ul style="list-style-type: none"> Value 0 = Perform Mode Value 1 = Params Mode
CC #61 Value 0-13	<p>Routing Mode parameter</p> <p>Value 0-13 = Grid > I/Os > Multi Out</p>

10

Cortex Cloud

Once you log in to your Neural DSP account, your Quad Cortex is ready to create Cloud Backups and share Presets, Neural Captures, and Impulse Responses.

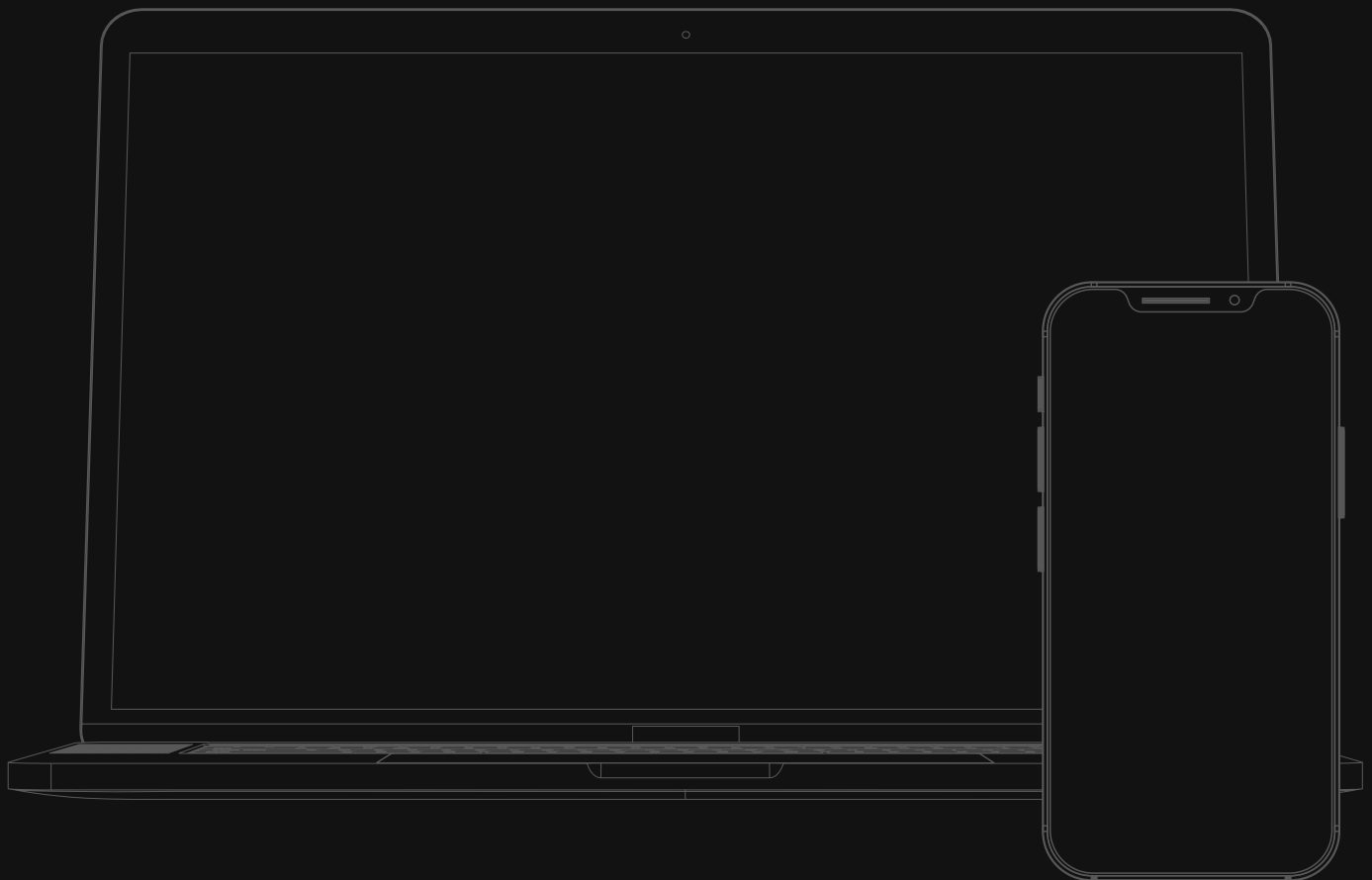

Cloud Backups

This feature allows you to securely backup all of the settings and data on your Quad Cortex, including Presets, Neural Captures, and Impulse Responses.

Link your account

First, link your Quad Cortex with your Neural DSP account. Go to the dropdown menu, tap on Settings and check the “My Account” section.



Linking your Neural DSP account unlocks the full potential of your Cortex Cloud profile.

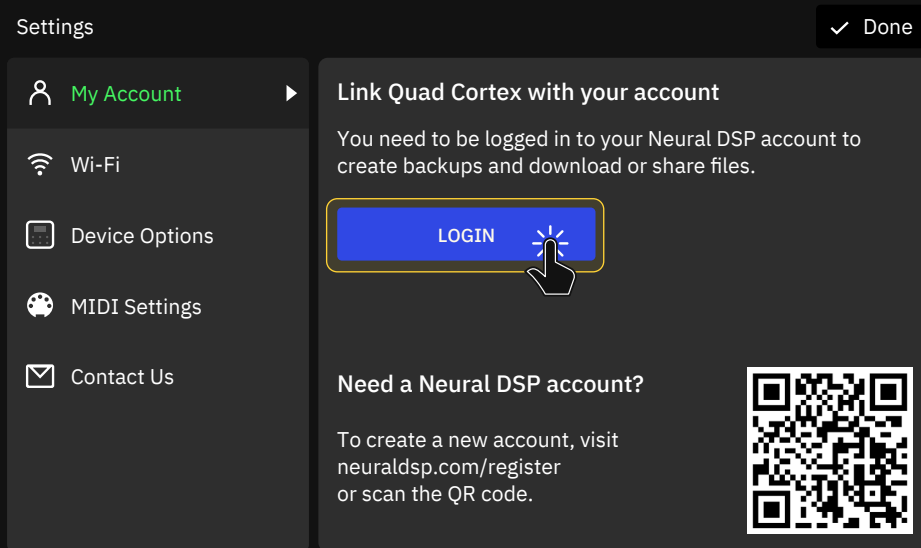

Once you log in into your Neural DSP account you will gain access to these three functions for **Cloud Backups**.

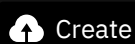
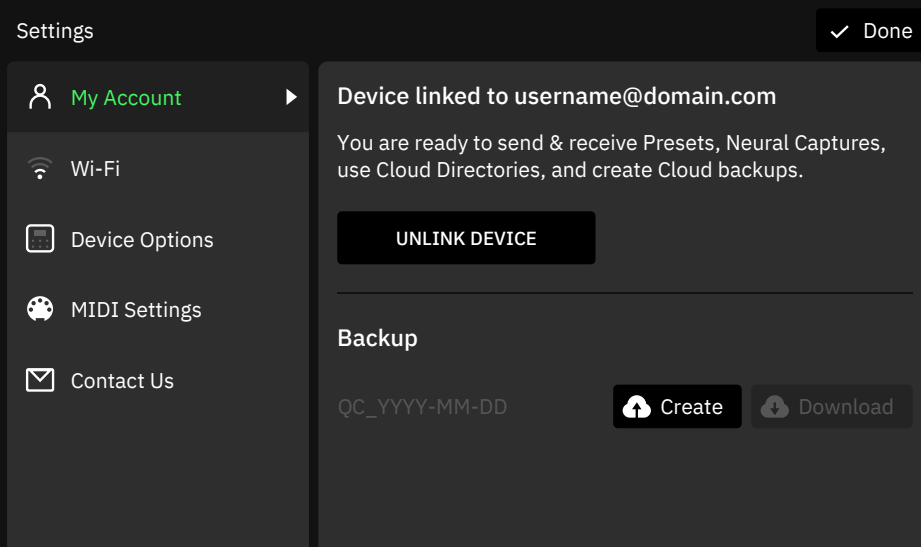

Backups your data for the first time.

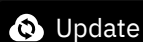

This will replace your Cloud backup with a new backup.

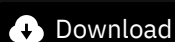

This will replace your current Quad Cortex files and settings with the ones in your Cloud backup.

Adding friends

In the Cortex ecosystem, friends can share files with each other, even if they are set to private. To become friends with someone, you both have to be followers of each other.

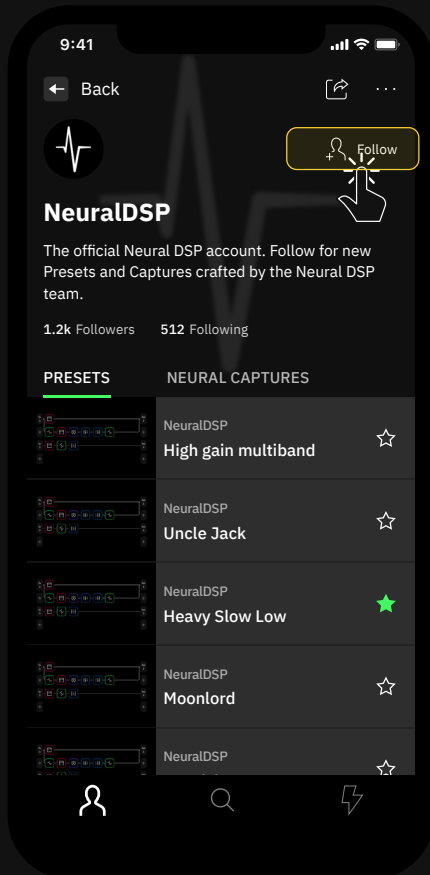

1. Use the Discover page's search function to search for a user.
2. Tap the **"Follow"** button next to the user you wish to follow. The status will change to **"Following"**.
3. When they follow you back, you will be friends, and will see each other on your Friends lists.
4. You can share your items with a friend via Quad Cortex or Cortex Cloud, even if your items are private.
5. Shared items will be available for download on your Quad Cortex, under **Directory / Shared with me**.



Directory

Category	Item Name	Creator	Action
Presets	Uncle Jack	Created by Frank Lambert	Download
	Preset name	Created by John	Download
	Preset name	Created by Francisco	Download
Neural Captures	Neural Capture	Created by Username2	Download
	Uncle Jack	Created by Frank Lambert	Download

Downloading items from other users

Presets and Neural Captures that are made public can be downloaded by anybody.



Check the [Making Presets or Neural Captures available to the public](#) section for more details.

1. On **Cortex Mobile**, find an item you'd like to download.
2. Tap the star icon ★
3. Connect to Wi-Fi on your Quad Cortex.
4. Go to the **Directory**.
5. Navigate to **Starred Presets** or **Starred Neural Captures**.
6. Tap to store the item(s) you starred.

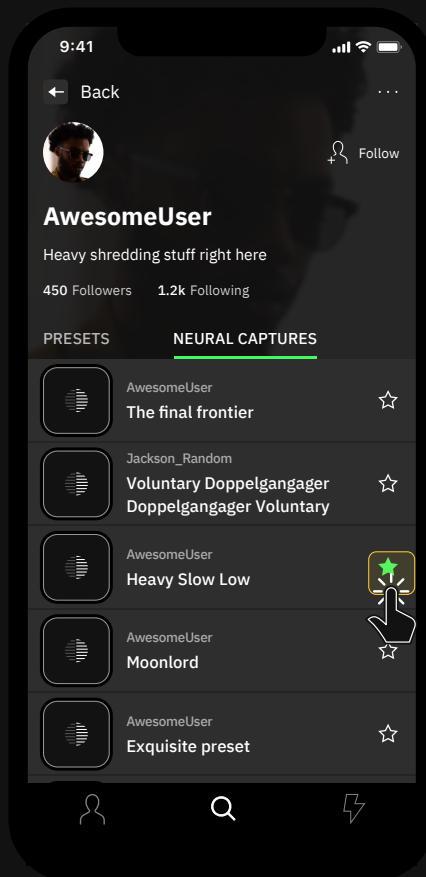

Directory

Search Refresh Done

Presets	★ Dougs 2010 Rig Created by Neural DSP	Download
Neural Captures	★ Preset name Created by Username	Download
Impulse Responses	★ Well_crafted one Created by Username	Download
STARRED AND SHARED WITH ME		
★ Presets	★ Clean_or_not Created by Username	Download
★ Neural Captures		
Shared with me		

Uploading Impulse Responses

To add IRs to your Quad Cortex you need to login into **Cortex Cloud** on our website.



Neural DSP
[Login](#) page here.

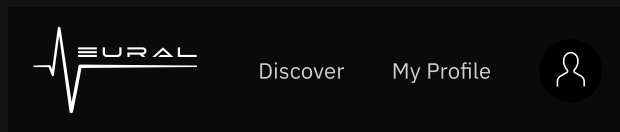

1. Login to your **Neural DSP account**.
2. Click on **Cortex Cloud**.
3. Click on **My Profile** then check the **Impulse Response** section.
4. Drag-and-drop impulse response files from your computer to the upload area. Alternatively use the **“Browse”** button.

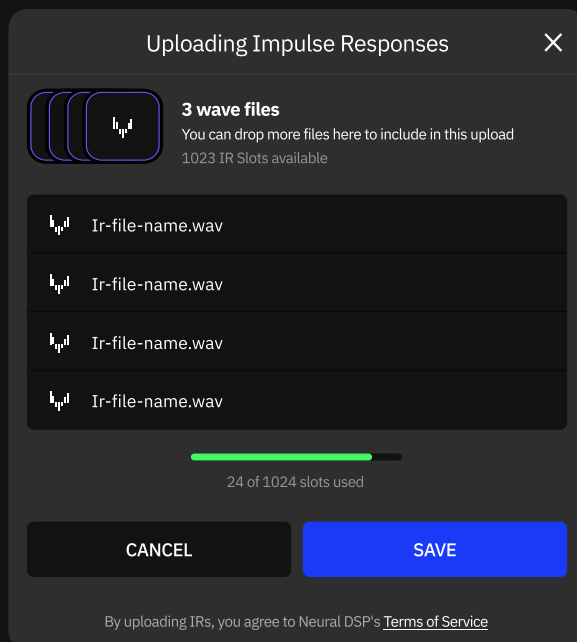
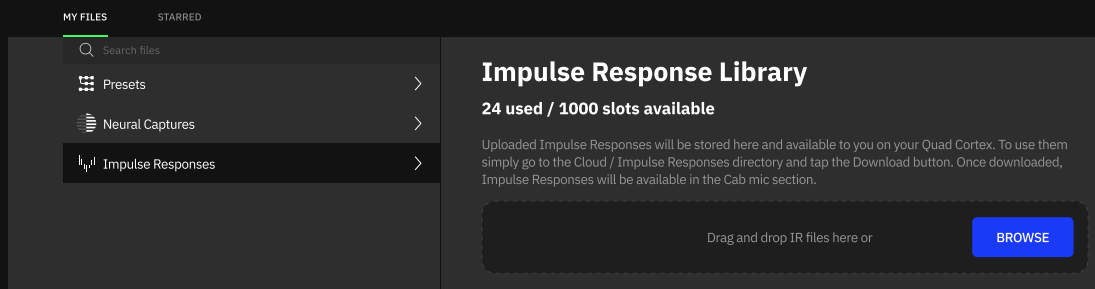

5. Click on **Save** to finish.

IMPORTANT: Any compatible WAV file can be uploaded to the Cloud no matter its length. The files will be resized to 1024 samples after being uploaded (*21 milliseconds approx*).

Importing Impulse Responses

1. On your Quad Cortex, open the Directory and navigate to the Impulse Responses folder beneath **Cloud Directories**.
2. Tap the Store button on the IRs you'd like to use, or tap the **Download all** button at the top to download all available IRs to your Quad Cortex.

For more details how to use imported Impulse Responses, check the section [Using External IR files](#).

Downloading all IRs at once will overwrite all IR files with the same name.

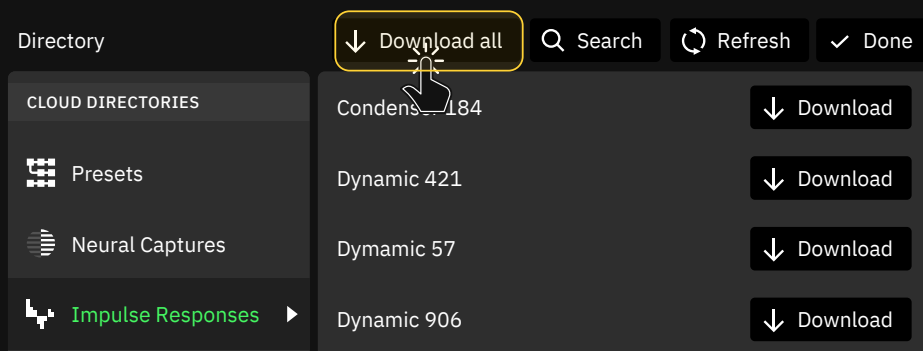

3. IRs will be downloaded to the **Impulse Responses** folder beneath Device Directories and will fill any available slots. You can rearrange them by dragging-and-dropping.

Uploading a Preset or a Neural Capture to Cortex Cloud

When you upload a Preset or Neural Capture to Cortex Cloud, its privacy status is **Private** by default. To change it so that it is available to the public, edit it on the Cortex Cloud website or via Cortex Mobile.



It is possible to share private Presets with friends.

Open the Directory and navigate to the file you want to upload to Cortex Cloud. Drag-and-drop it to the top of the screen, where the **Copy to Cloud** zone will show. Your file will instantly upload to Cortex Cloud and be available on your account.

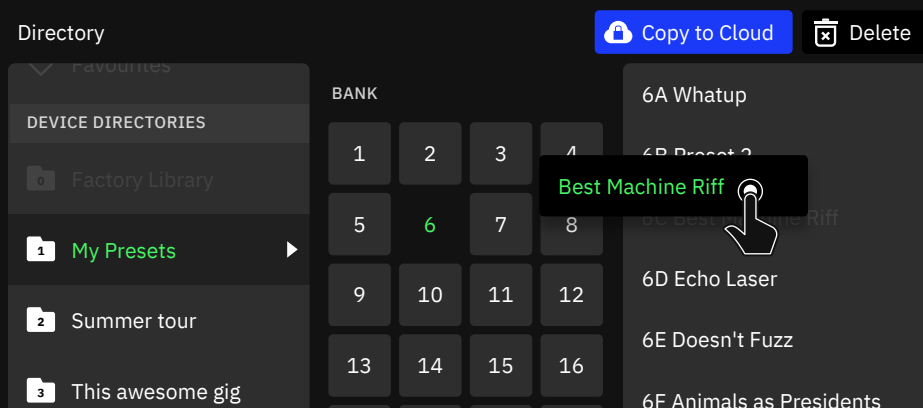

Sharing Presets or Neural Captures with a friend

To share a Preset or Neural Capture, you first have to upload it to **Cortex Cloud**. Once uploaded, use the **Cortex Mobile App** for sharing.

1. Go to your Profile.
2. Select the item you would like to share then tap 
3. Tap the name of your friend on the list. Multiple friends can also be selected.
4. Confirm the action by tapping “Send”.

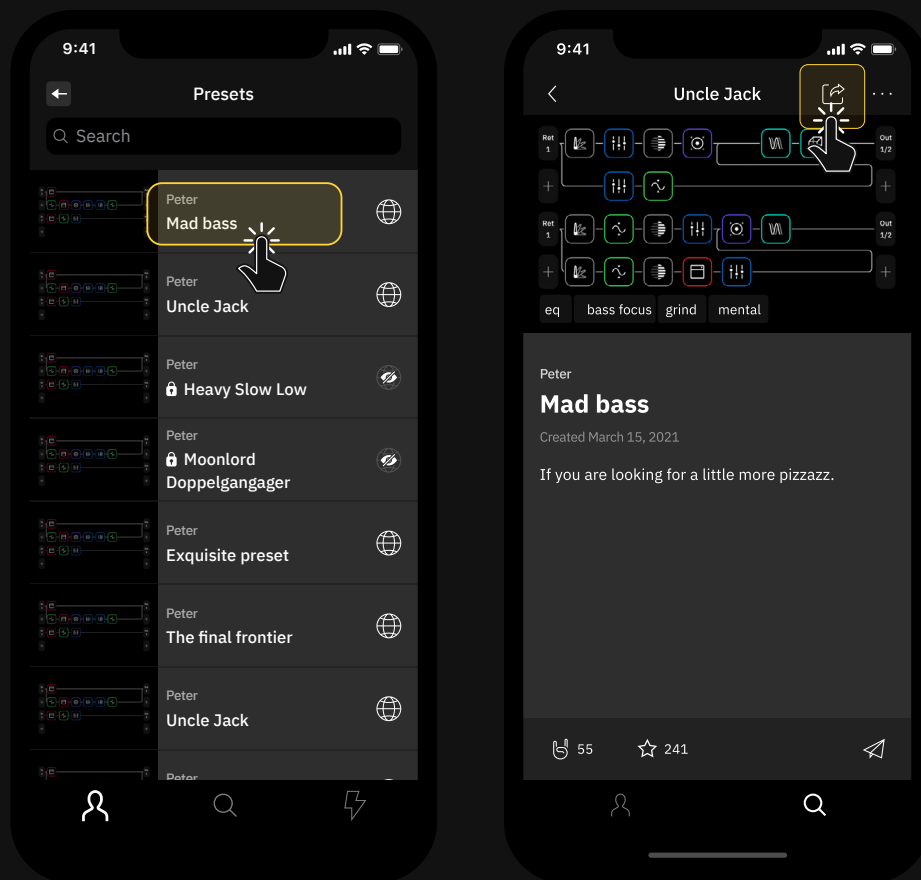

Making Presets or Neural Captures available to the public

Your Preset or Neural Capture has to be uploaded to Cortex Cloud first.

If you want your items to be easy to find, make sure to add tags. Adding a short description is ideal!

— Using Cortex Mobile

1. Navigate to your profile.
2. Open the Preset or Neural Capture you'd like to make available to the public.
3. Tap the hidden globe icon in the top-right corner.
4. The lock will disappear and your item will be available for everyone to find, download, and star.

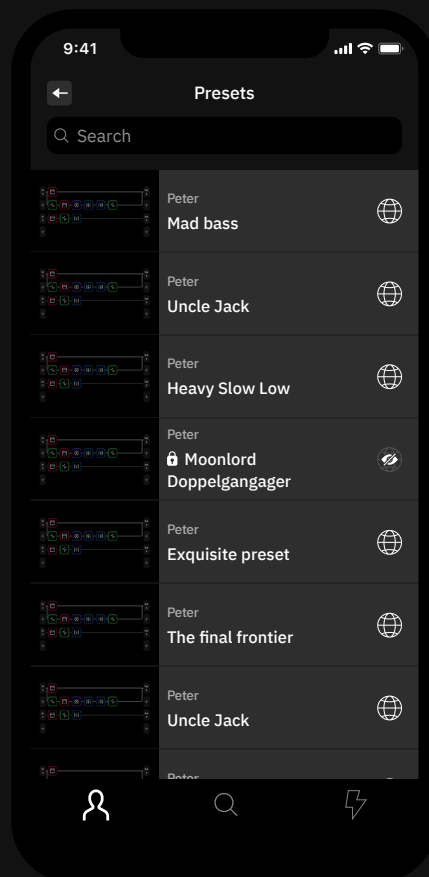
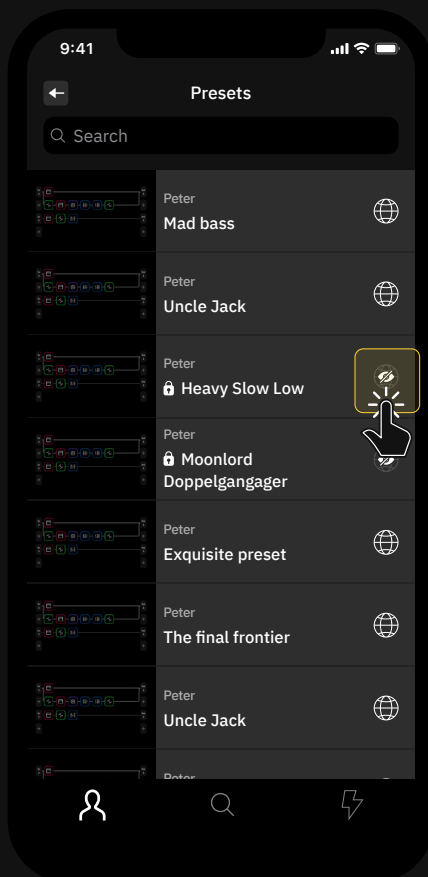

11

Virtual Device List

All product names are trademarks of their respective owners, which are in no way associated or affiliated with Neural DSP. These product names, descriptions, and images are provided for the sole purpose of identifying the specific products that were studied during Quad Cortex's sound model development.

— Guitar Amps



- Bogna Vishnu 20th Clean (Bogner® Shiva® 20th Anniversary)
- Bogna Uber Clean (Bogner® Uberschall® Rev. Blue) **New**
- Bogna Uber Lead (Bogner® Uberschall® Rev. Blue) **New**
- Brit 2203 (Marshall® JCM800®)
- Brit 900 Clean (Marshall® JCM900® 4100)
- Brit 900 Lead (Marshall® JCM900® 4100)
- Brit Plexi 100 Bright (Marshall® Super Lead 100®)
- Brit Plexi 100 Normal (Marshall® Super Lead 100®)
- Brit Plexi 100 Patch (Marshall® Super Lead 100®)
- Brit Plexi 50 Bright (Marshall® Lead 50®)
- Brit Plexi 50 Normal (Marshall® Lead 50®)
- Brit Plexi 50 Patch (Marshall® Lead 50®)
- Brit TM45 Bright (Marshall® JTM 45®)
- Brit TM45 Normal (Marshall® JTM 45®)
- Brit TM45 Patch (Marshall® JTM 45®)
- Brit UBL Lead (Marshall® Silver Jubilee®)
- Brit UBL Lead Clip (Marshall® Silver Jubilee®)
- CA 1Star Clean 100W Normal (Mesa® Boogie® Lone Star®)
- CA 1Star Clean 100W Tweed (Mesa® Boogie® Lone Star®)
- CA 1Star Clean 50W Normal (Mesa® Boogie® Lone Star®)
- CA 1Star Clean 50W Tweed (Mesa® Boogie® Lone Star®)
- CA 1Star Drive 100W Normal (Mesa® Boogie® Lone Star®)
- CA 1Star Drive 100W Tweed (Mesa® Boogie® Lone Star®)
- CA 1Star Drive 50W Normal (Mesa® Boogie® Lone Star®)
- CA 1Star Drive 50W Tweed (Mesa® Boogie® Lone Star®)
- Captain 50 (Morgan® SW50®)
- CA Duo Ch3 Modern (Mesa® Boogie® Dual Rectifier®)
- CA Duo Ch3 Raw (Mesa® Boogie® Dual Rectifier®)
- CA Duo Ch3 Vintage (Mesa® Boogie® Dual Rectifier®)
- CA Tremo Orange (Mesa® Boogie® Trem-O-Verb®)

- CA Tremo Red (Mesa® Boogie® Trem-O-Verb®)
- D-Cell Hisbert Ch1 (Diezel® Herbert®) **New**
- D-Cell Hisbert Ch2 (Diezel® Herbert®) **New**
- D-Cell Hisbert Ch3 (Diezel® Herbert®) **New**
- D-Cell H4 Ch1 Bright (Diezel® VH4®)
- D-Cell H4 Ch1 Normal (Diezel® VH4®)
- D-Cell H4 Ch2 Bright (Diezel® VH4®)
- D-Cell H4 Ch2 Normal (Diezel® VH4®)
- D-Cell H4 Ch3 (Diezel® VH4®)
- D-Cell H4 Ch4 (Diezel® VH4®)
- EV101III Blue (EVH® 5150 III® 100S® EL34)
- EV101IIIS Blue 6L6 100W (EVH® 5150® 6L6 Tubes)
- EV101III Red (EVH® 5150 III® 100S® EL34)
- EV101IIIS Red 6L6 100W (EVH® 5150® 6L6 Tubes)
- Freeman 100 Clean (Friedman® HBE100®)
- Freeman 100 Lead (Friedman® HBE100®)
- Freeman 100 Rhythm (Friedman® HBE100®)
- PV-505 Lead (Peavey® 6505®)
- PV-505 Rhythm (Peavey® 6505®)
- Rols Jazz CH120 (Roland® Jazz Chorus 120®)
- Solo 100 Crunch Bright (Soldano® SLO® 100®)
- Solo 100 Crunch Normal (Soldano® SLO® 100®)
- Solo 100 Lead (Soldano® SLO® 100®)
- UK C15 Boost (Vox® AC15®)
- UK C15 Normal (Vox® AC15®)
- UK C30 Normal (Vox® AC30®)
- UK C30 TopBoost (Vox® AC30®)
- US DLX Normal (Fender® Blackface Deluxe Reverb®)
- US DLX Vibrato (Fender® Blackface Deluxe Reverb®)
- US HP Tweed TWIN Bright (Fender® High Power Tweed Twin 5F8-A®) **New**
- US HP Tweed TWIN Bright Jumped (Fender® High Power Tweed Twin 5F8-A®) **New**
- US HP Tweed TWIN Normal (Fender® High Power Tweed Twin 5F8-A®) **New**
- US HP Tweed TWIN Normal Jumped (Fender® High Power Tweed Twin 5F8-A®) **New**
- US SPR Normal (Fender® Super Reverb® '65)
- US SPR Vibrato (Fender® Super Reverb® '65)
- US Prince (Fender® Blackface Princeton Reverb®)
- US TWN Normal (Fender® Twin Reverb®)
- US TWN Vibrato (Fender® Twin Reverb®)

- US Tweed Basslad Bright (Fender® Bassman® Tweed)
- US Tweed Basslad Bright Jumped (Fender® Bassman® Tweed)
- US Tweed Basslad Normal (Fender® Bassman® Tweed)
- US Tweed Basslad Normal Jumped (Fender® Bassman® Tweed)
- Watt D103 Bright (Hiwatt® DR103®)
- Watt D103 Normal (Hiwatt® DR103®)

— Bass Amps



- Amped Flip-Top 6464 (Ampeg® Heritage® B15N®)
- Amped Flip-Top 6466 (Ampeg® Heritage® B15N®)
- Amped Flip-Top 6664 (Ampeg® Heritage® B15N®)
- Amped Flip-Top 6666 (Ampeg® Heritage® B15N®)
- Amped Super Valve (Ampeg® Heritage® SVT-CL®)
- Brit Bass 50 Bright (Marshall® Super Bass® 50)
- Brit Bass 50 Normal (Marshall® Super Bass® 50)
- Brit Bass 50 Patch (Marshall® Super Bass® 50)
- CA 400+ Ch1 (Mesa® Boogie® Bass 400+®)
- CA 400+ Ch2 (Mesa® Boogie® Bass 400+®)
- G800K (Gallien Krueger® 800RB®)
- Watt Bass Mod Bright (Hiwatt® DR103® Mod)
- Watt Bass Mod Normal (Hiwatt® DR103® Mod)

— Neural Capture



- Banger Fish+290 (Bogner® Fish®) + (Mesa® Boogie® Stereo Simul-Class™ 2:Ninety™)
- Banger Uber (Bogner® Überschall®)
- Cravin X100 (Carvin® X100B® Series IV)
- Custom 3SE+290 (Custom Audio Amplifier® 3+SE®) + (Mesa® Boogie® Stereo Simul-Class™ 2:Ninety™)
- Corn Vixen (Cornford® Hellcat®)
- D-Cell Herb (Diezel® Herbert®)
- NGL Marty's (ENGL® Inferno® Marty Friedman Signature)
- NGL Energy (ENGL® Powerball® Mark I)
- NGL Rainbow (ENGL® Ritchie Blackmore Signature 100®)
- Prince 65 (Fender® Princeton® 65)
- NoMatch Chief (Matchless® Chieftain®)
- Fryed Sig10 (Fryette® SigX®)
- Comet 60 (Komet® 60)
- Crank Rev1 (Krank® Rev1)
- Cali John's (Mesa® Boogie® JP2C®)
- Cali M2C+ (Mesa® Boogie® Mark IIC+®)
- Cali Quad+290 (Mesa® Boogie® Quad Preamp®) + (Mesa® Boogie® Stereo Simul-Class™ 2:Ninety™)
- Cali Studio+290 (Mesa® Boogie® Studio Preamp®) + (Mesa® Boogie® Stereo Simul-Class™ 2:Ninety™)
- Cali 3Axe+290 (Mesa® Boogie® Triaxis®) + (Mesa® Boogie® Stereo Simul-Class™ 2:Ninety™)
- Cali M3Red (Mesa® Boogie® Mark III Red Stripe®)
- Range Rock (Orange® Rocker® 30)
- Range Rockverb (Orange® Rockerverb® 100 MK3)
- Range Stormverb (Orange® Thunderverb® 50)
- Paul's MT15 (Paul Reed Smith® MT15)
- PV 505Sig (Peavey® 5150® Signature)
- Victor Marshal (Victory® Sheriff® 22)
- Victor Mega Squid (Victory® Super Kraken®)
- ABA MPre1 (ADA® MP1® Preamp)
- Banger Fish (Bogner® Fish®)
- Custom 3SE (Custom Audio Amplifier® 3+SE®)
- Cali 3Axe (Mesa® Boogie® Triaxis®)
- BBD SonicMax (BBE® Sonic Stomp Sonic Maximizer®)
- Banger Xtacy Blue (Bogner® Ecstasy Blue®)
- Iba SD9 (Ibanez® Sonic Distortion 9®)
- Iba TS9 (Ibanez® Tube Screamer 9®)

- MadPro Golden (Mad Professor® Golden Cello®)
- MadPro SimpleOD (Mad Professor® Simple Overdrive®)
- MX ClassicOD (MXR® Classic Distortion®)
- Exotic BB (Xotic Effects® BB Preamp®)
- Exotic SL (Xotic Effects® SL Drive®)
- Amped SV Classic (Ampeg® SVT Classic®)
- Amped V4B (Ampeg® V-4B®)
- Rat+SV (ProCo® Rat®) + (Ampeg® SVT Classic®)
- Rat+V4B (ProCo® Rat®) + (Ampeg® V-4B®)
- Cali BassWalk (Mesa® Boogie® Walkabout™)
- Cali BigBrick750 (Mesa® Boogie® Big Block 750®)
- Cali M6Rifle (Mesa® Boogie® M6 Carbine®)
- Cali MixBass (Mesa® Boogie® M6 Carbine® & Big Block 750® Mixed)
- Darkglass AO900 (Darkglass® Alpha·Omega 900®)
- Darkglass MT900V2 (Darkglass® Microtubes 900® V2)
- Range AD200 (Orange® AD200 Bass MK3®)
- SCity B120 (Sound City® B120®)
- Warwitch ProF5 (Warwick® Pro Fet 5.1®)
- Anima Fuzz (Human Gear® Animato®)
- Chief ODB3 (Boss® ODB-3®)
- MX BassFuzzDLX (MXR® Bass Fuzz Deluxe®)
- Darkglass AOU (Darkglass® Alpha·Omega Ultra®)
- Darkglass B7K (Darkglass® B7K®)
- Darkglass VU (Darkglass® Vintage Ultra®)
- Darkglass VMT (Darkglass® Vintage Microtubes®)
- Darkglass VMT+B7K (Darkglass® Vintage Microtubes® & B7K® Mixed)
- Tech41 BDDI (Tech21® Bass Driver DI®)
- Tech41 VTBassDLX (Tech21® VT Bass Deluxe®)
- Tech41 PSA (Tech21® SansAmp® PSA®)
- D-Cell PA-6550 (Diezel® Herbert® 6550®)
- NGL PA-930 (ENGL® Tube Poweramp® 930/60)
- Brit PA-EL34 (Marshall® Silver Jubilee 2555®)
- Cali PA-Sim290 (Mesa® Boogie® Stereo Simul-Class™ 2:Ninety™)
- OMG PA-KT66 (Omega Ampworks® KT66® Poweramp)
- VHD PA-2502 (VHT® Two/Fifty/Two®)

— Cabs



IRs by Neural DSP

- 110 US PRN C10R (Fender® Princeton® with Jensen® C10R drivers)
- 112 UK C15 Blue (Vox® AC15® with Celestion® Alnico Blue drivers)
- 410 US Basslad PR10 (Fender® Bassman® Tweed with Jensen® P10R drivers)

IRs by Adam “Nolly” Getgood

- 412 CA Stand OS A V30 ,03 (Mesa® Oversize Angle 2003 with Celestion® UK Vintage 30)
- 112 US DLX SC64 (Fender® Deluxe® 1x12 Eminence® GA-SC64)
- 412 Brit 35B Alnico Cream (Marshall® 1935B® Alnico Cream)
- 212 CA Recto Legend V12 (Mesa® Rectifier® 2x12 Legend V12)
- 212 Zila Fatboy V30 ,02 (Zilla® Fatboy 2x12 2002 with Celestion® UK Vintage 30)
- 115 Amped Modern (Ampeg® SVT® 115HE®)
- 810 Amped VT Aln 70s (Ampeg® SVT® 810® with custom Eminence® ceramic drivers)
- 412 ENG Pro V30 18 (ENGL® V30®)
- 210 Darkglass® Neo (Darkglass® DG212N® with custom Eminence® neodymium drivers)
- 412 Brit 35A GB55Hz '75 (Marshall® 1935A® with Celestion® G12M25 drivers)
- 412 Brit 60A GB75Hz '89 (Marshall® 1960A® with Celestion® G12M25 drivers)
- 412 Brit 60B V30 '95 (Marshall® 1960B® with Celestion® Marshall® Vintage 30 drivers)
- 412 Brit TV GB75Hz '69 (Marshall® 1960TV® with Celestion® G12M25 drivers)
- 412 CA Stand OS A V30 '01 (Mesa® Standard OS Angled with Celestion® Vintage 30 drivers)
- 412 CA Trad A V30 '92 (Mesa® Traditional Angled with Celestion® Vintage 30 drivers)
- 412 CA Trad S H30 '15 (Mesa® Traditional Straight with Celestion® G12H30 drivers)
- 212 CA Recto V30 '98 (Mesa® Rectifier® with Celestion® Vintage 30 drivers)
- 412 Range PPC V30 '02 (Orange® PPC412 with Celestion® Vintage 30 drivers)
- 212 Rols Jazz '87 (Roland® JC-120®)
- 212 UK C30 '65 (VOX® AC30® Top Boost with Celestion® Alnico “Silver Bell” drivers)
- 410 US Basslad P10Q '16 (Fender® Bassman® with Jensen® P10Q drivers)
- 210 US TRMLX Oxf '63 (Fender® Tremolux® with Oxford® Alnico drivers)
- 112 US DLX Black C12K 00s (Fender® Deluxe® “Blackface” with Jensen® C12K drivers)
- 112 US DLX Tweed WGS-Q 10s (Fender® Deluxe® “Tweed” with WGS® G12Q drivers)
- 110 US PRN Brown FatJ 10s (Fender® Princeton® with FatJimmy® C1060 Drivers)
- 212 US TWN C12Q 00s (Fender® Twin Reverb® with Jensen® C12K-2 drivers)
- 212 US TWN CK2 (Fender® Twin Reverb® 2x12 Jensen C12K-2)
- 412 Watt S4123 (Hiwatt® SE4123® 4x12)
- 412 Zila Cust V30 '12 V2 (Zilla® Custom with Celestion® Vintage 30 drivers)
- 112 Zila MiniMod RB '17 (Zilla® Mini Modern with Celestion® G12H150 Redback drivers)
- 212 Zila Open Gold '19 (Zilla® Open with Celestion® Alnico Gold drivers)

Other third party IRs

- 210C Darkglass® (Darkglass® D210C® with custom Eminence® ceramic drivers)
- 412 D-Cell Front V30 '04 (Diezel® Front Loaded with Celestion® Vintage 30 drivers)
- 412 EV Straight G12 00s (EVH® Straight with Celestion® G12EVH drivers)
- 412 Brit Silver B 70w '87 (Marshall® 2551B® with Celestion® drivers)
- 412 Brit 60B GB 90s (Marshall® 1960B® with Celestion® Greenback drivers)
- 412 Brit 60B GB '71 (Marshall® 1960B® with Celestion® Pulsonic Greenback drivers)
- 412 CA Trad S UKV30 90s (Mesa® Traditional Straight with Celestion® Vintage 30 drivers)
- 412 CA Stand OS S V30 90s (Mesa® Standard OS Straight with Celestion® Vintage 30 drivers)
- 412 Range PPC V30 '03 (Orange® PPC412 with Celestion® Vintage 30 drivers)
- 212 Sur V-type 10 (Suhr® Cab with Celestion® V-Type drivers)
- 412 Bogna Uber T75 00s (Bogner® Ubercab® with Celestion® T75 drivers)
- 412 Bogna Uber V30 00s (Bogner® Ubercab® with Celestion® Vintage 30 drivers)
- 212 UK C30 GB '69 (VOX® AC30® with Celestion® Pre-Rola Greenback Pulsonic drivers)
- 212 US A-type 00s (Fender® Cab with Celestion® A-Type 12" drivers)
- 212 Zila CB '16 (Zilla® Cab with Celestion® Creamback G12H-75 drivers)

— Guitar Overdrive



- Brit Blues (Marshall® BluesBreaker®)
- Brit Governor (Marshall® Guv'nor®)
- Chief BD2 (BOSS® BD-2®)
- Chief DS1 (BOSS® DS-1®)
- Chief MT (BOSS® MT-2®)
- Chief OD1 (BOSS® OD-1®)
- Chief SD1 (BOSS® SD-1®)
- Obsessive Drive (Fulltone® OCD®)
- Exotic (Xotic® BB Preamp®)
- Exotic Z Boost (Xotic® RC Booster®)
- Facial Fuzz (Dunlop® Fuzzface®)
- Freeman BOD (Friedman® BE-OD®)
- Fuzz Pi (Electro-Harmonix® Big Muff Pi®)
- Green 808 (Ibanez® TS808®)
- Myth Drive (Klon® Centaur®)
- No-Bell OD1 (Nobels® ODR-1®) **New**
- OD250 (DOD® Overdrive Preamp 250®)
- Rage Booster (Dallas® Rangemaster®)
- Red Drive (Keeley Electronics® Red Dirt®) **New**
- Rodent Drive (ProCo® Rat®)
- Vemural Ray (Vemuram® Jan Ray®) **New**

— Bass Overdrive



- BDDI (Tech 21® Bass Driver DI®)
- Exotic Bass Z Boost (Xotic® RC Bass Booster®)
- Microtubes B3K (Darkglass® Microtubes B3K®)
- Microtubes VMT (Darkglass® Vintage Microtubes®)
- Soviet Fuzz (Electro-Harmonix® Russian Big Muff®)

— Delay



- Analog Delay
- Analog Delay (Mono)
- Slapback Delay
- Slapback Delay (Mono)
- Digital Delay (Stereo & Mono)
- Dual Delay **New**
- Ping Pong Delay
- Simple Delay (Stereo & Mono)
- Tape Delay (Stereo & Mono)

— Reverb

- Ambience
- Cave
- Hall
- Mind Hall
- Modulated
- Plate
- Plate Lush
- Plate Tight
- Room
- Spring (Stereo & Mono)



— Compressor

- Chief CS3 (BOSS® CS-3® Compression Sustainer) **New**
- Jewel (Diamond® Compressor®)
- Legendary 87 (Universal Audio® 1176®)
- Legendary 87 (Stereo) (Universal Audio® 1176®) **New**
- Opto Comp
- Opto Comp (Stereo) **New**
- Solid State Comp (SSL® Bus)
- Solid State Comp (Stereo) (SSL® Bus) **New**
- VCA Comp
- VCA Comp (Stereo) **New**



— Pitch

- Minivoicer **New**
- Pitch Shifter
- Poly Octaver (Electro-Harmonix® POG®)
- Wham (Digitech® Whammy®)



— Modulation

- Chief CE2W (BOSS® CE-2W®)
- Chief CE2W (Mono) (BOSS® CE-2W®)
- Chief DC2W (BOSS® DC-2W® Dimension) **New**
- Chief DC2W (Mono) (BOSS® Dimension DC-2W®) **New**
- Chorus 229T (TC Electronic® TC-2290®)
- Chorus Engine
- Digital Flanger
- Dream Chorus (TC Electronic® Dreamscape®)
- Dream Chorus (Mono) (TC Electronic® Dreamscape®)



- Dual Chorus
- Flanger Engine
- Flangerish
- MX Flanger (MXR® Flanger M117R®)
- MX Phase 95 (MXR® Phase 95®) **New**
- NuVibes
- Phaser
- Rotary
- Tremolo
- Vibrato
- Vintage Chorus

— Morph

- Freeze



— Filter

- Env. Filter
- Foog (Moog® Moogerfooger® MF-101)
- Love Meat (Lovetone® Meatball®)



— EQ

- Graphic-9
- Low-High Cut
- Parametric-3
- Parametric-8



— Wah

- Bad Horse (Morley® Bad Horsie®)
- Bass Wah
- Bubba Wah (Dunlop® Budda Budwah®)
- Crying Wah (Dunlop® Cry Baby® GCB-95®) **New**



— Looper

- Looper X



— Utility

- Adaptive Gate
- Gain
- Simple Gate
- Utility Gate



12

F.A.Q.

Can I load Neural DSP plugins on my Quad Cortex unit?

You are able to log in to your Neural DSP account on your Quad Cortex. Doing so will give it access to your account billing history and make the plugins you have purchased available.

This feature will be available through a free update after launch.

How do I update the firmware on my Quad Cortex?

You can update to the latest version of CorOS in the Settings by opening the **Main Menu** at the top-right corner of the The Grid.

Go to **Device Options**, make sure your Quad Cortex is connected to Wi-Fi, and tap **Device updates**. If an update is available, it will download immediately.

After installing an update, you will need to reboot your Quad Cortex.

What is FRFR and why do you recommend it?

FRFR means “full range, flat response”. It describes a “neutral” speaker or speaker system designed to reproduce the entire human audible spectrum of 20Hz – 20kHz without any emphasis.

This kind of speaker is great for the Quad Cortex because you get the truest representation with the cabinet simulator and microphone placement.

Examples of FRFR systems include high-quality studio monitors and PA systems. Some FRFR systems are designed specifically for direct guitar and bass guitar applications.

Can I connect the Quad Cortex to an amplifier?

Yes, but there is a reason behind recommending FRFR devices instead of running Quad Cortex into setups that could color the signal.

Most tube amplifiers have distinct tonal properties, so using Quad Cortex with an FRFR device is the best way to take full advantage of the tonal capabilities without introducing undesired tone coloration.

If you want to use Quad Cortex with a tube or solid-state amp, we recommend trying the **4 Cable Method**.

Do the inputs support a variety of powered instruments?

Yes. Input impedance and gain are adjustable via the I/O Settings screen.

How can I take advantage of the ground-cancelling outputs (Send 1-2)?

This feature works by connecting Quad Cortex to external devices by using a modified instrument cable (TRS and TS ends). Connect the TRS tip to the Quad Cortex and the TS tip to the external device.

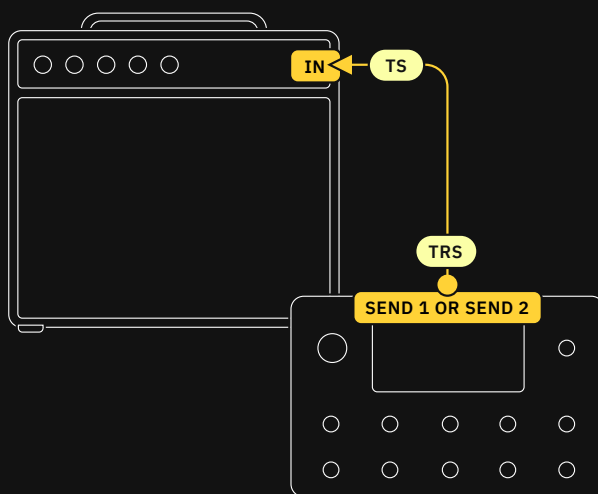

These cables do not eliminate noise, but they can significantly reduce hum caused by ground loops.

Both Sends 1 and 2 support this feature.

Is there gapless switching between Scenes & Presets?

Preset changing will incur in the inevitable familiar gap. You can use **Scene** and **Stomp modes** to change sounds while maintaining delay trails without any crossfade/gaps.

Can I load third party or my own custom Impulse Responses?

Yes. Impulse Responses can be uploaded via Cortex Cloud and downloaded on your Quad Cortex.

What do MSB and LSB mean?

They mean **Most Significant Byte** and **Least Significant Byte**.

A program change that also selects a bank is composed of three MIDI messages:

CC#0: Bank Select (MSB)

- **Value 0:** Preset group 0~127
- **Value 1:** Preset group 128~256

CC#32: Setlist (LSB)

- **PC#:** Program Change message 0~127

I'm hearing audio crackle noise and pops...

Check all your cables. We recommend looking for damage in both long and short cables. Next, check if any of the I/O is clipping in the **I/O Settings** or if any block is clipping on The Grid.

Excessive CPU usage may also be the cause. Is the **CPU meter** above 80% or 90%? If so, you may have overloaded the current Preset.

My Preset produces no sound at all...

Is every physical component working properly? Check your cables, the connections, and make sure the VOLUME KNOB is raised.

After that, take a look at The Grid. Are the input and output blocks properly configured? Are other Presets working?

Finally, take a look at the I/O Settings. Maybe some of the GAIN knobs are all the way down.

13

Specifications

— Mic/Inst Inputs 1-2

- Connectors: (2) XLR-F + ¼" TS with Ground Lift
- TS Impedance: 10K Ω - 10M Ω
- XLR Impedance: 9.4K Ω
- Max Input Gain: +60 dB

— Return Inputs 1-2

- Connectors: (2) ¼" TRS with Ground Lift
- Impedance: 1M Ω
- Max Input Gain: +60 dB

— Analog Outputs 1-2

- Connectors: (2) XLR-M with Ground Lift
- Impedance: 560 Ω
- Max Output Level: +9.5dBu

— Analog Outputs 3-4

- Connectors: (2) TRS
- Impedance: 560 Ω
- Max Output Level: +15.5dBu balanced, +9.5dBu unbalanced

— Send Outputs 1-2

- Connectors: (2) ¼" TRS (Ground-cancelling outputs)
- Impedance: 560 Ω
- Maximum Output Level: +9.5dBu

For more information check the FAQ: [How can I take advantage of the Ground-Cancelling outputs \(Send 1-2\)?](#)

— Headphone Output

- Connectors: ¼" TRS
- Output Power (max): 300mW

— Expression Pedal Inputs

- Connectors: (2) ¼" TRS

— MIDI Ports

- Input Connector: 5-pin DIN + USB MIDI Input
- Output Connector: 5-pin DIN + USB MIDI Input

— USB Audio

- Format: USB Audio Class 2.0 Compliant
- Channels: 16 (8in/8out, each mapped to a specific source or connector)
- USB Audio Clock: 48 kHz fixed

— General

- Finish: Anodized aluminum unibody
- Controls: 11 stainless steel stomp + rotary actuators, 1 volume knob
- Display: 7" high brightness
- Dimensions: 29 x 19 x 4.9cm
- Weight: 1.95kg / 4.2lbs
- Input Voltage: 12VDC 3A (negative polarity)
- Typical Power Consumption: 18W

— Environmental

- Operating Temperature: 32 to 122 °F (0 to 50 °C)
- Storage Temperature: 14 to 158 °F (-10 to 70 °C)
- Humidity: Maximum non-condensing

DECLARATION OF CONFORMITY

This equipment has been tested and found to comply with the limits for a Class B digital device, pursuant to part 15 of the FCC Rules. These limits are designed to provide reasonable protection against harmful interference in a residential installation. This equipment generates, uses and can radiate radio frequency energy, and if not installed and used in accordance with the instructions, may cause harmful interference to radio communications. However, there is no guarantee that interference will not occur in a particular installation. If this equipment does cause harmful interference to radio or television reception, which can be determined by turning the equipment off and on, the user is encouraged to try to correct the interference by one or more of the following measures:

- Reorient or relocate the receiving antenna
- Increase the separation between the equipment and receiver
- Connect the equipment into an outlet on a circuit different from that to which the receiver is connected
- Consult the dealer or an experienced radio/TV technician for help

This device complies with Industry Canada license exempt RSS standard(s). Operation is subject to the following two conditions:

- (1) This device may not cause interference, and
- (2) This device must accept any interference, including interference that may cause undesired operation of the device.

Le présent appareil est conforme aux CNR d'Industrie Canada applicables aux appareils radio exempts de licence. L'exploitation est autorisée aux deux conditions suivantes:

- (1) l'appareil ne doit pas produire de brouillage, et
- (2) l'utilisateur de l'appareil doit accepter tout brouillage radioélectrique subi, même si le brouillage est susceptible d'en compromettre le fonctionnement.

SUPPORT AND CONTACT INFORMATION

<https://support.neuraldsp.com/help>

For technical issues or any problems experienced with our software contact us on our website. Here you will find our FAQ (Frequently Asked Questions), our troubleshooting info (your question might have been asked before) and our contact email support@neuraldsp.com. Please be sure to contact this email only for support purposes. If you contact some other Neural DSP email, your support will be delayed.

CORPORATE CONTACT

Neural DSP OY
Tehtaankatu 27-29, 00150, Helsinki, Finland

© 2021 Neural DSP Technologies LLC. All rights reserved.

